

ACB | *Vento!*

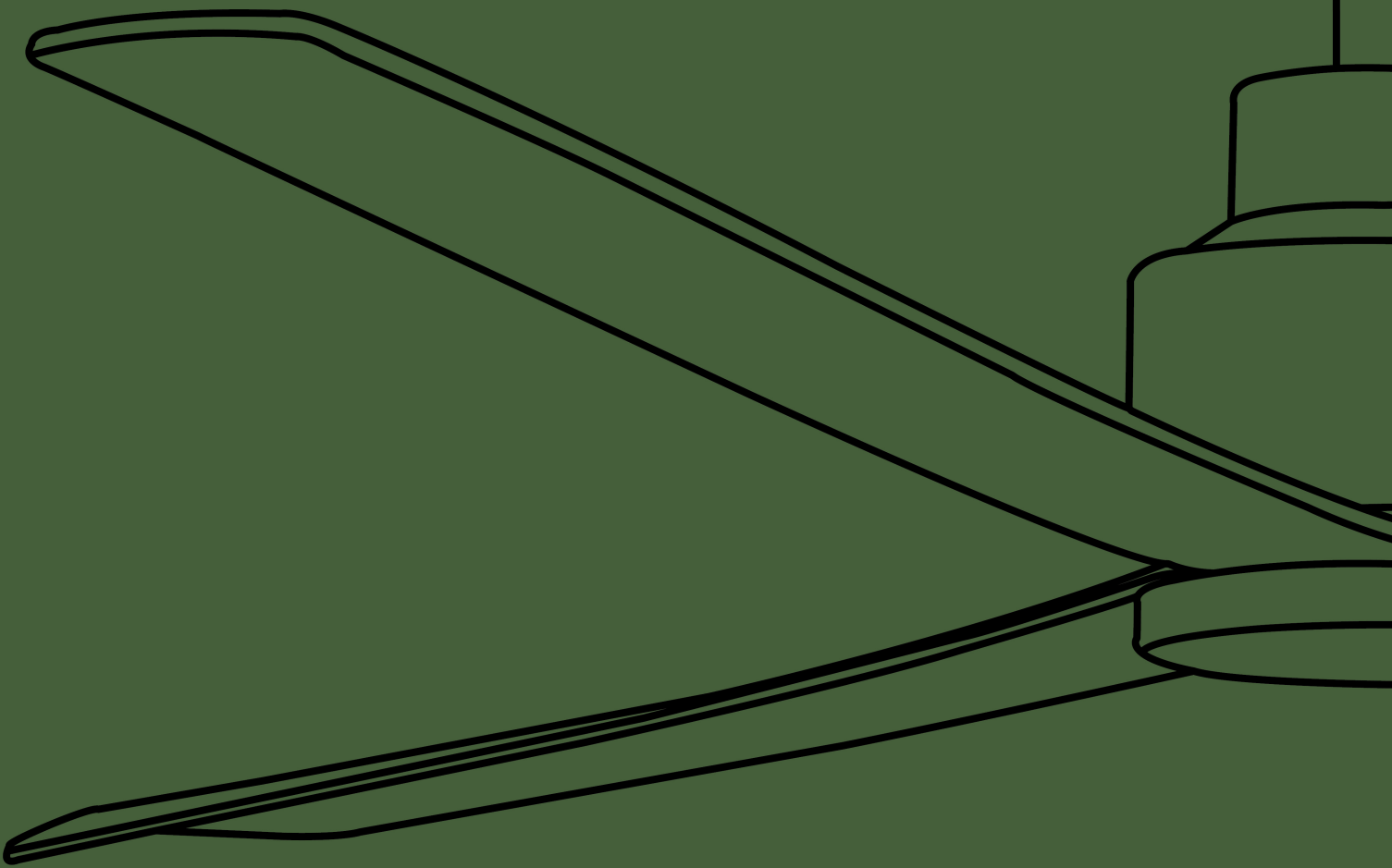

5



CÓMO ELEGIR TU VENTILADOR

• How to choose your fan • Comment choisir votre ventilateur •
 • Auswahl des geeigneten ventilators • Come scegliere il suo ventilatore •

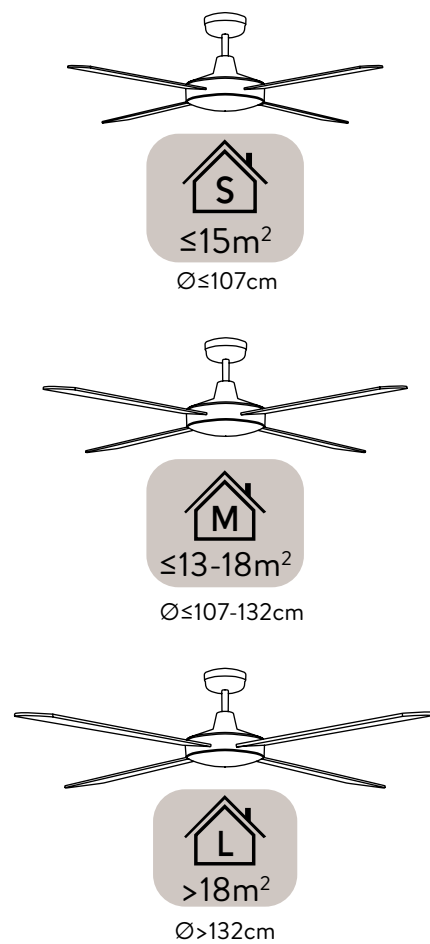

LUZ

Light • Lumière • Licht • Luce



Sin luz

Without light • Sans lumière • Ohne Licht • Senza luce

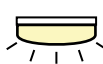

Con luz LED

With LED light • Avec lumière LED • Mit LED-Licht • Con luce LED

ASPAS

Blades • Pales • Schaufeln • Pale

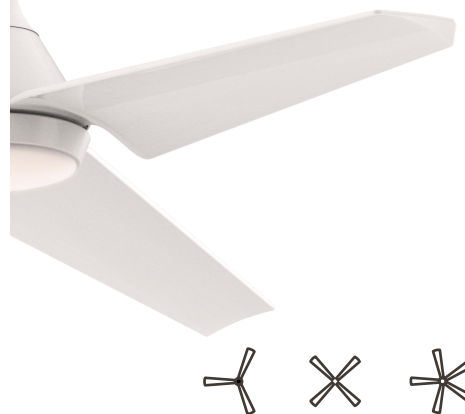

La cantidad de aire depende de la inclinación de las aspas, no del número de ellas.

The air flow depends on the inclination of the blades, not on the number of them.

Le débit d'air dépend de l'inclinaison des pales et non du nombre d'entre elles.

Der Luftstrom hängt von der Neigung der Schaufeln ab, nicht von deren Anzahl.

Il flusso dell'aria dipende dalla inclinazione delle pale, non dalla quantità.

FUNCIÓN VERANO - INVIERNO

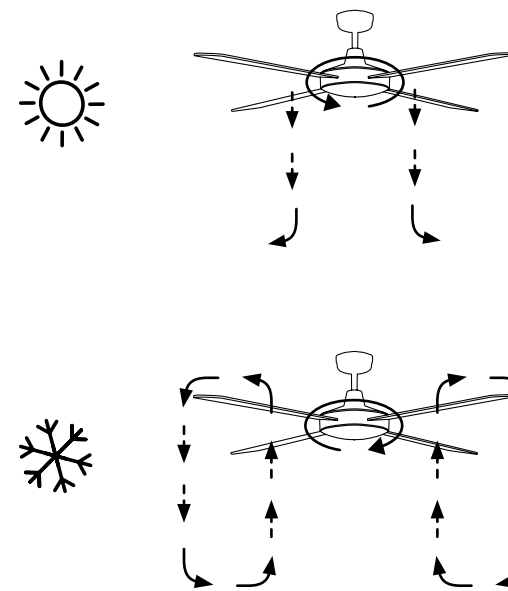

MOTOR

Motor • Moteur • Motor • Motore

AC
MOTOR

Corriente alterna con 3 velocidades

Alternating current with 3 speeds.
 Courant alterne avec 3 vitesses.
 Wechselstrom mit 3 Geschwindigkeiten.
 Corrente alterna con 3 velocità.

DC
MOTOR

Corriente continua con 6 velocidades

Direct current with 6 speeds.
 Courant continu avec 6 vitesses.
 Gleichstrom mit 6 Geschwindigkeiten.
 Corrente continua con 6 velocità.

ABS

ABS es un tipo de plástico muy resistente y aerodinámico

ABS is a kind of plastic, very resistant and aerodynamic.
 ABS est un type de plastique très résistant et aérodynamique
 ist eine Art Kunststoff, sehr widerstandsfähig und aerodynamisch.
 ABS è una specie di plastica, molto resistente e aerodinamica.

PC

PC es un tipo de plástico muy resistente y transparente

PC is a kind of plastic, very resistant and transparent.
 PC est un type de plastique très résistant et transparent.
 PC ist eine Art Kunststoff, sehr widerstandsfähig und transparent.
 PC è una specie di plastica, molto resistente e trasparente.

PLYWOOD

Contrachapado es un derivado de la madera con mucha resistencia

Plywood is a very resistant material derived from wood.
 Contre-plaqué est un dérivé du bois très résistant.
 Sperrholz ist ein sehr widerstandsfähiges Material, das aus Holz erzeugt wird.
 Compensato è un materiale molto resistente derivato dal legno.

WOOD

Las aspas de madera son mas silenciosas

Wooden Blades are quieter.
 Les pales en bois sont plus silencieuses.
 Hölzerne Schaufeln sind leiser.
 Le pale di legno sono più silenziose.

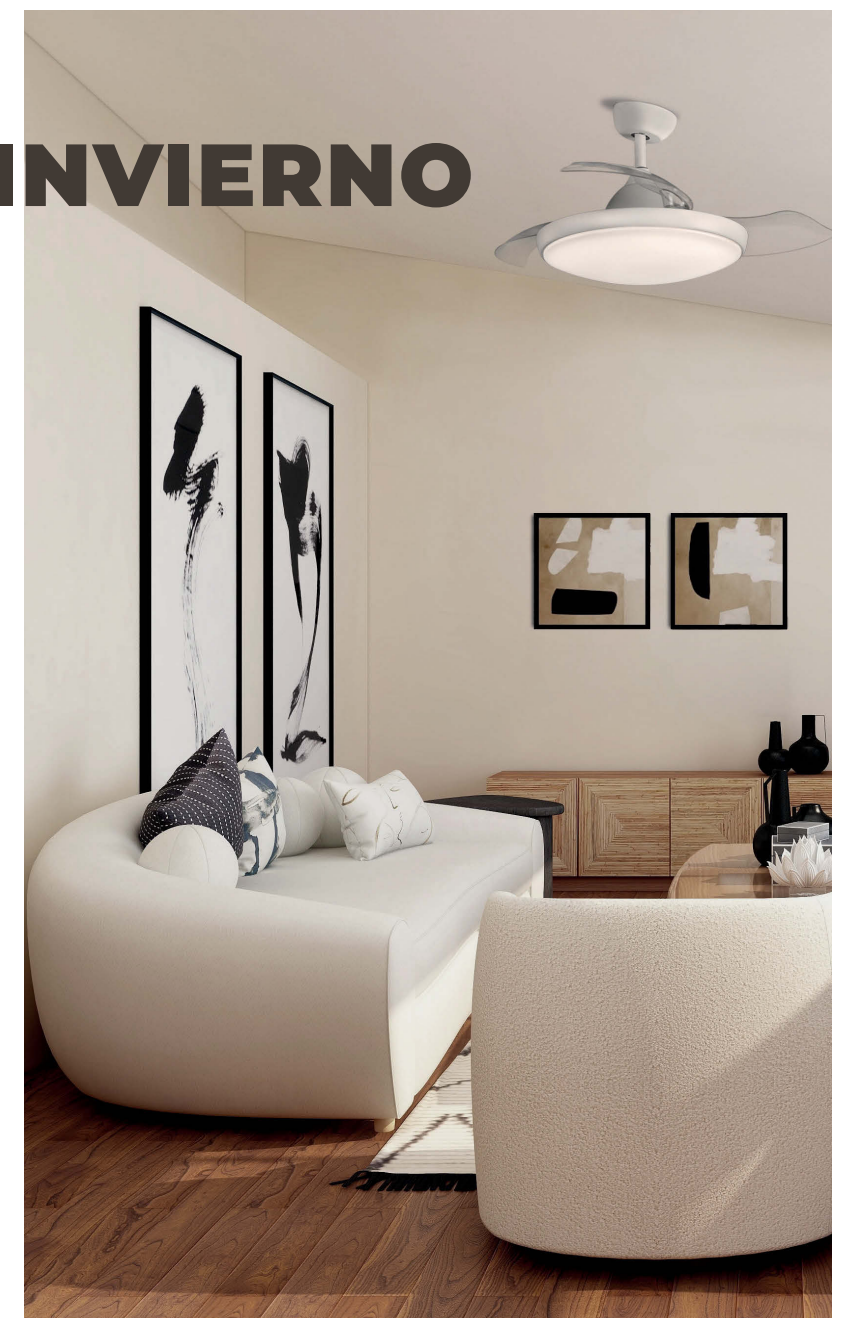



Function summer - winter • Fonction été - hiver •
 Funktion Sommer - Winter • Funzione estate - inverno

MATERIAL















































































Material • Matériel • Material • Materiale

ÍNDICE

Index / Indice / Index / Indice

| NOMBRE | DIBUJO | IP | MOTOR | | | | LUZ | | | |
|--------|---|------|----------|------|----------|---|---|------------------------------------|----------------|------------|
| | | | Grado IP | Tipo | Potencia | Velocidades | Función | Luz | Steps Kelvin | Lumens |
| ZONDA |  | IP44 | DC MOTOR | 33W | 6 |  |  | 3 Steps 3000K 4000K 6000K | 4000 | LED 47W |
| BORA |  | IP44 | DC MOTOR | 30W | 6 |  |  - DIM + | 3 Steps 3000K 4000K 6000K | 2000 | LED 20W |
| BARINE |  | - | DC MOTOR | 32W | 6 |  |  - DIM + | 3 Steps 3000K 4000K 6000K | 2300 | LED 24W |
| BRISA |  | - | DC MOTOR | 30W | 6 |  |  | 3000K | 1140 | LED 15W |
| BISE |  | - | DC MOTOR | 35W | 6 |  |  | 3 Steps 3000K 4000K 6500K | 2400 | LED 24W |
| SHAMAL |  | - | DC MOTOR | 35W | 6 |  |  | 3 Steps 3000K 4000K 6500K | 2200 | LED 22W |
| GARBIN |  | - | DC MOTOR | 30W | 6 |  |  | - | - | - |
| SIROCO |  | - | DC MOTOR | 35W | 6 |  |  | - | - | - |
| | <i>Kit Luz (*)</i> | - | - | - | - | - |  | 3 Steps 3000K 4000K 6500K | 2200 | LED 22W |
| ROK |  | - | DC MOTOR | 32W | 6 |  |  | - | - | - |
| | <i>Kit Luz (*)</i> | - | - | - | - | - |  - DIM + | 3 Steps 3000K 4000K 6500K | 1200 | LED 18W |
| GREGAL |  | - | DC MOTOR | 35W | 6 |  |  | - | - | - |
| | <i>Kit Luz (*)</i> | - | - | - | - | - |  | 3 Steps 3000K 4000K 6500K | 1800 | LED 18W |

(*) Kit Luz no incluido en el producto, pedir por separado

| TAMAÑO | | PESO | AIRFLOW | ASPAS | | | MANDO | | COLOR | CÓDIGO | PÁG. |
|-----------------------|---|--|---|---|----------|-------------|---|---|---|------------|-------|
| Diámetro | Estancia | Kg | Flujo de aire | Número y forma | Material | Reversibles | Sí/No | Temporizador | SKU | Nº | |
| Ø48/107cm 18.9/42" |  ≤13-18m² |  5.5 |  102 m³/min 3600 CFM |  | ABS | - |  |  |  | V25144232B | 6-7 |
| Ø132cm 52" |  ≤13-18m² |  5.2 |  185 m³/min 6533CFM |  | ABS | - |  |  |  | V2516523B | 8-9 |
| Ø132cm 52" |  ≤13-18m² |  6.1 |  166 m³/min 5865 CFM |  | ABS | - |  |  |  | V25064231B | 10-11 |
| Ø132cm 52" |  ≤13-18m² |  5.7 |  189 m³/min 6677CFM |  | ABS | - |  |  |  | V2503520B | 12-13 |
| Ø92cm 36" |  ≤15m² |  5.5 |  147 m³/min 5200CFM |  | PLYWOOD | ✓ |  |  |  | V2521030B | 14-15 |
| Ø132cm 52" |  ≤13-18m² |  5.5 |  168 m³/min 5955CFM |  | PLYWOOD | ✓ |  |  |  | V2522030B | 16-17 |
| Ø132cm 52" |  ≤13-18m² |  7.2 |  149 m³/min 5264 CFM |  | WOOD | - |  |  |  | V250252XNM | 18-19 |
| Ø132cm 52" |  ≤13-18m² |  6.3 |  152 m³/min 5380 CFM |  | WOOD | - |  |  |  | V2519040B | 20-21 |
| - | - | - | - | - | - | - | - | - |  | K2003030B | |
| Ø132cm 52" |  ≤13-18m² |  3.3 |  143 m³/min 5055 CFM |  | WOOD | - |  |  |  | V2518040B | 22-25 |
| - | - | - | - | - | - | - | - | - |  | V2518040N | |
| - | - | - | - | - | - | - | - | - |  | K2001030B | |
| - | - | - | - | - | - | - | - | - |  | K2001030N | |
| Ø132cm 52" |  ≤13-18m² |  4.6 |  154 m³/min 5460 CFM |  | ABS | - |  |  |  | V2520040B | 26-29 |
| - | - | - | - | - | - | - | - | - |  | V2520040N | |
| - | - | - | - | - | - | - | - | - |  | V2520041N | |
| - | - | - | - | - | - | - | - | - |  | K2002030B | |
| - | - | - | - | - | - | - | - | - |  | K2002030N | |



ZONDA

IP44





OFF

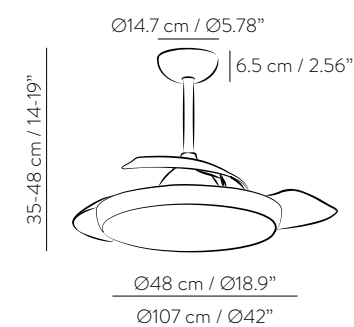

ON



 **V25144232B** PVP 219€

| | |
|------------------------|---|
| Acabado | <input type="checkbox"/> Blanco / Opal |
| Motor | 33W |
| Velocidades |  1 - 2 - 3 - 4 - 5 - 6 |
| RPM | 161 - 169 - 176 - 189 - 209 - 232 |
| Decibelios | 33,2dB - 35,1dB - 36,7dB - 37dB - 37,3dB - 38,5dB |
| Airflow | 102m ³ /min CFM 3600 |
| Luz | LED 47W 4000lm 3 Steps 3000K - 4000K - 6000K |
| Material Cuerpo | Metal / Acrílico |
| Material Aspas | ABS |
| Peso | 5.5 Kg |
| Mando |  |

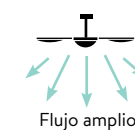





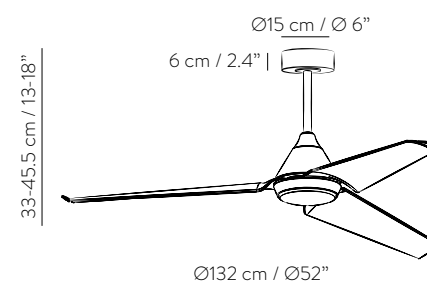

BORA

IP44



 **V2516523B** **PVP 236€**

| | | |
|------------------------|---|---|
| Acabado | <input type="checkbox"/> Blanco / Opal |  Flujo amplio |
| Motor | 30W | |
| Velocidades |  1 - 2 - 3 - 4 - 5 - 6 | |
| RPM | 68 - 93 - 110 - 124 - 139 - 150 | |
| Decibelios | 23dB - 30dB - 33dB - 38dB - 42dB - 46dB | |
| Airflow | 185m ³ /min CFM 6533 | |
| Luz | LED 20W 2000lm 3 Steps 3000K - 4000K - 6000K | |
| Material Cuerpo | Metal / Acrílico | |
| Material Aspas | ABS | |
| Peso | 5.2 Kg | |
| Mando |  | |

DC MOTOR





BARINE

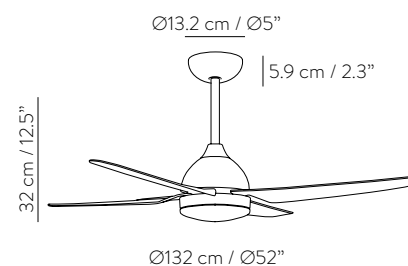

 **V25064231B** **PVP 185€**

| | | |
|------------------------|---|---|
| Acabado | <input type="checkbox"/> Blanco / Opal |  Flujo amplio |
| Motor | 32W | |
| Velocidades |  1 - 2 - 3 - 4 - 5 - 6 | |
| RPM | 98 - 131 - 160 - 187 - 219 - 255 | |
| Decibelios | 42dB - 48dB - 49dB - 57dB - 58dB - 65dB | |
| Airflow | 166m ³ /min CFM 5865 | |
| Luz | LED 24W 2300lm 3 Steps 3000K - 4000K - 6000K | |
| Material Cuerpo | Metal / Acrílico | |
| Material Aspas | ABS | |
| Peso | 6.1 Kg | |
| Mando |  | |





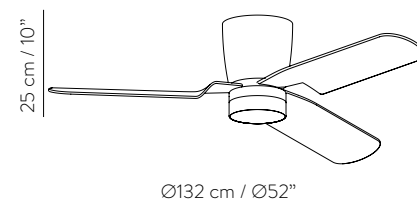

BRISA

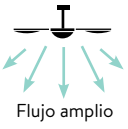

 **V2503520B** PVP 255.20€

| | | |
|------------------------|---|---|
| Acabado | <input type="checkbox"/> Blanco / Opal |  Flujo amplio |
| Motor | 30W | |
| Velocidades |  1 - 2 - 3 - 4 - 5 - 6 | |
| RPM | 72 - 101 - 127 - 140 - 151 - 187 | |
| Decibelios | 32,3dB - 33dB - 33,6dB - 34dB - 36,9dB - 40,5dB | |
| Airflow | 189m ³ /min CFM 6677 | |
| Luz | LED 15W 1140lm 3000K | |
| Material Cuerpo | Metal / ABS / Cristal | |
| Material Aspas | ABS | |
| Peso | 5.7 Kg | |
| Mando |  | |





BISE

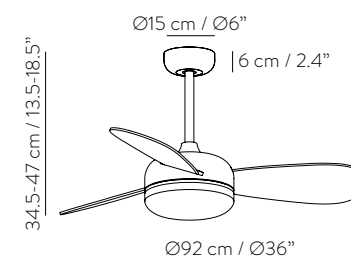

(*) Longitud de tija de 60cm / 23.6" opcional.

○ 5TIJ0002B PVP 19€

CONTROLADORES DE PARED COMPATIBLES

BATERIA 2xAAA AC 220-240V



XCONTROL034 PVP 29€ XCONTROL035 PVP 29€

(Medidas ver pagina 30)

⬇️ ■ V2521030B PVP 219€

| | |
|------------------------|--|
| Acabado | ■ Blanco / Haya |
| Motor | 35W |
| Velocidades | ⚙️ 1 - 2 - 3 - 4 - 5 - 6 |
| RPM | 105 - 140 - 166 - 185 - 205 - 220 |
| Decibelios | 36dB - 37dB - 39dB - 41dB - 42dB - 44dB |
| Airflow | 147m ³ /min CFM 5200 |
| Luz | LED 24W 2400lm 3 Steps 3000K - 4000K - 6500K |
| Material Cuerpo | Metal |
| Material Aspas | Plywood |
| Peso | 5.5 Kg |
| Mando | 📱 |

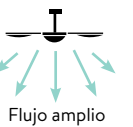



SHAMAL

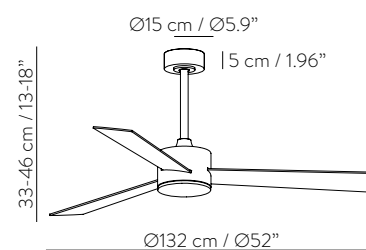

(*) Longitud de tija de 60cm / 23.6" opcional.

○ 5T1J0002B PVP 19€

CONTROLADORES DE PARED COMPATIBLES

BATERIA 2xAAA AC 220-240V



XCONTROL034 PVP 29€ XCONTROL035 PVP 29€

(Medidas ver pagina 30)

⬇️ ◻️ V2522030B PVP 220€

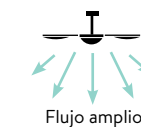

| | |
|------------------------|--|
| Acabado | ◻️ Blanco / Haya |
| Motor | 35W |
| Velocidades | ⚙️ 1 - 2 - 3 - 4 - 5 - 6 |
| RPM | 117 - 151 - 180 - 198 - 219 - 230 |
| Decibelios | 37dB - 38dB - 40dB - 42dB - 43dB - 45dB |
| Airflow | 168m ³ /min CFM 5955 |
| Luz | LED 22W 2200lm 3 Steps 3000K - 4000K - 6500K |
| Material Cuerpo | Metal |
| Material Aspas | Plywood |
| Peso | 5.5 Kg |
| Mando | 📱 |





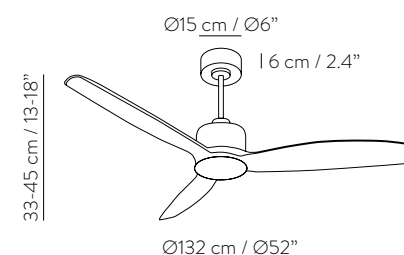

GARBIN



  **V250252XNM** PVP 299€

| | |
|------------------------|---|
| Acabado |  Negro / Nogal |
| Motor | 30W |
| Velocidades |  1 - 2 - 3 - 4 - 5 - 6 |
| RPM | 63 - 121 - 146 - 165 - 179 - 203 |
| Decibelios | 31,5dB - 32dB - 32,5dB - 33,4dB - 36,2dB - 39,7dB |
| Airflow | 149m ³ /min CFM 5264 |
| Material Cuerpo | Metal |
| Material Aspas | Madera maciza |
| Peso | 7.2 Kg |
| Mando |  |

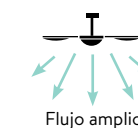

12,5 cm / 5"
25 cm / 10"





SIROCO



CONTROLADORES DE PARED
COMPATIBLES

BATERIA 2xAAA AC 220-240V



XCONTROL034 PVP 29€ XCONTROL035 PVP 29€

(Medidas ver pagina 30)

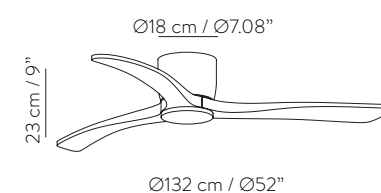

V2519040B PVP 269€

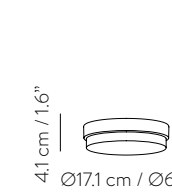

KIT LUZ opcional

LED 22W | 2200LUM
3 Steps



K2003030B PVP 39€

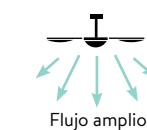

- Acabado** Blanco | Haya
- Motor** 35W
- Velocidades** 1 - 2 - 3 - 4 - 5 - 6
- RPM** 90 - 109 - 126 - 150 - 170 - 190
- Decibelios** 36dB - 37dB - 39dB - 41dB - 42dB - 45dB
- Airflow** 152m³/min | CFM 5380
- Material Cuerpo** Metal
- Material Aspas** Madera maciza
- Peso** 6.3 Kg
- Mando**

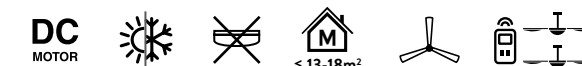

ROK



+ KIT LUZ





ROK



+ KIT LUZ

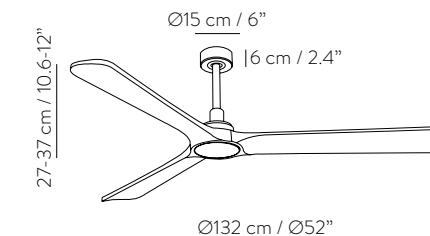

3 Steps LED 18W | 1800LUM



- V2518040B** PVP 239€
- V2518040N** PVP 239€

- KIT LUZ opcional**
- K2001030B** PVP 32€
 - K2001030N** PVP 32€

- Acabado** Blanco | Haya Negro | Nogal
- Motor** 32W
- Velocidades** 1 - 2 - 3 - 4 - 5 - 6
- RPM** 95 - 108 - 123 - 142 - 160 - 182
- Decibelios** 22,5dB - 23,1dB - 30,1dB - 39dB - 41,3dB - 45,6dB
- Airflow** 143m³/min | CFM 5055
- Material Cuerpo** Metal
- Material Aspas** Madera maciza
- Peso** 3.34 Kg
- Mando**

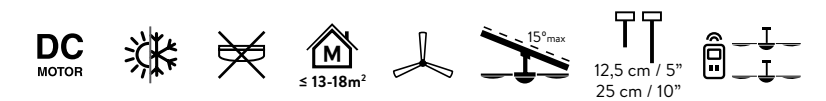
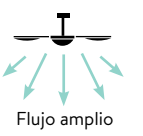

GREGAL



+ KIT LUZ



+ KIT LUZ



+ KIT LUZ



GREGAL



CONTROLADORES DE PARED COMPATIBLES

BATERIA 2xAAA AC 220-240V



XCONTROL034 PVP 29€ XCONTROL035 PVP 29€

(Medidas ver pagina 30)

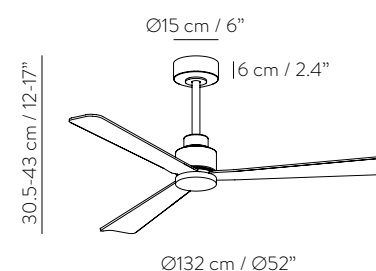

3 Steps LED 18W | 1800LUM



(*) Longitud de tija de 60cm / 23.6" opcional.

○ STIJ0002B ● STIJ0002N PVP 19€

□ V2520040B PVP 225€
 ■ V2520040N PVP 225€
 ■ V2520041N PVP 225€

KIT LUZ opcional
 ■ K2002030B PVP 38€
 ■ K2002030N PVP 38€

Acabado ■ Negro / Negro ■ Negro / Nogal □ Blanco / Blanco

Motor 35W

Velocidades 6 1 - 2 - 3 - 4 - 5 - 6

RPM 123 - 160 - 188 - 212 - 228 - 243

Decibelios 35dB - 36dB - 39dB - 40dB - 42dB - 44dB

Airflow 154m³/min | CFM 5460

Material Cuerpo Metal

Material Aspas ABS

Peso 4.6 Kg

Mando

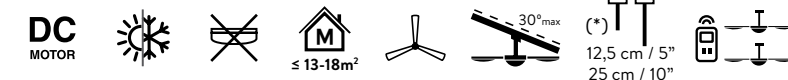
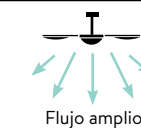

SIMBOLOGÍA

Symbology / Symbologie / Symbolik / Simbologia

- Negro**
Black · Noir · Schwarz · Nero
- Blanco**
White · Blanc · Weiß · Bianco
- Opal/Fumé**
Opal/Smoked · Opale/Fumé · Opal/Fumé · Opale/Fumé
- Nogal**
Walnut · Noyer · Walnuss · Noce
- Haya**
Beech · Hêtre · Buche · Faggio
- Motor AC**
AC Motor · Moteur AC · AC Motor · Motore AC
- Motor DC**
DC Motor · Moteur DC · DC Motor · Motore DC
- Potencia del motor**
Engine power · Puissance du moteur · Motorleistung · Potenza del motore
- 6 Velocidades**
6 Speeds · 6 Vitesses · 6 Geschwindigkeiten · 6 Velocità
- Peso**
Weight · Le poids · Gewicht · Peso
- Tamaño de la habitación: S**
Size of the room: S · Taille de la salle: S · Größe des Raumes: S · Dimensione della stanza: S
- Tamaño de la habitación: M**
Size of the room: M · Taille de la salle: M · Größe des Raumes: M · Dimensione della stanza: M
- Tamaño de la habitación: L**
Size of the room: L · Taille de la salle: L · Größe des Raumes: L · Dimensione della stanza: L
- Flujo de aire**
Airflow · Débit d'air · Luftstrom · Flusso d'aria
- 3 Aspas**
3 Blades · 3 Pales · 3 Schaufeln · 3 Pale
- 4 Aspas**
4 Blades · 4 Pales · 4 Schaufeln · 4 Pale
- 3 Aspas**
3 Blades · 3 Pales · 3 Schaufeln · 3 Pale
- Adecuado para techos inclinados**
Suitable for sloping roof · Convient aux toits en pente · Geeignet für Dachschrägen · Adatto a tetto inclinato
- Función verano - invierno**
Summer - Winter function · Fonction été - hiver · Sommer - Winterfunktion · Funzione estate - inverno

- Material de las aspas: ABS**
Material of the blades: ABS · Matériau des pales: ABS · Material der Schaufeln: ABS · Materiale delle pale: ABS
- Material de las aspas: Policarbonato**
Material of the blades: Polycarbonate · Matériau des pales: Polycarbonate · Material der Schaufeln: Polycarbonat · Materiale delle pale: Policarbonato
- Material de las aspas: Contrachapado**
Material of the blades: Plywood · Matériau des pales: Contre-plaqué · Material der Schaufeln: Sperrholz · Materiale delle pale: compensato
- Material de las aspas: Madera maciza**
Material of the blades: Solid Wood · Matériau des pales: Bois solide · Material der Schaufeln: Massivholz · Materiale delle pale: Legno massiccio
- Aspas reversibles bicolor: blanco mate y madera clara**
Reversible blades: matt white and pale wood · Pales interchangeable: blanc mat et bois claire · Wendbare Klappen: mattweißes und helles Holz · Pale intercambiabili: bianco opaco e legno chiaro
- Sin luz**
Without light · Sans lumière · Ohne Licht · Senza luce
- Con luz LED**
With LED light · Avec lumière LED · Mit LED-Licht · Con luce LED
- Dimable en intensidad de luz (desde el mando)**
Dimmable light intensity (from the remote control) · Intensité lumineuse réglable (à partir de la télécommande) · Intensità luminosa dimmerabile (dal telecomando)
- Dimable Kelvin 3000K-4000K-6000K (desde el interruptor de pared)**
Kelvin Dimmable (from the wall switch) · Dimmable Kelvin (à partir de l'interrupteur mural) · Dimmbar Kelvin (vom Wandschalter) · Dimmerabile Kelvin (desde el interruptor de pared)
- Lumens**
Lumens · Lumens · Lumens · Lumens
- Temperatura de color**
Colour temperature · Température de couleur · Farbtemperatur · Temperatura di colore
- Potencia de la luz**
Power of light · Puissance de la lumière · Lichtleistung · Potenza della luce
- Mando incluido**
Remote control included · Télécommande inclus · Fernbedienung enthalten · Telecomando inclusi
- Temporizador**
Timer · Minuterie · Timer · Timer
- El mando se puede vincular a varios ventiladores**
The control can be linked to several fans · La commande peut être reliée à plusieurs ventilateurs · The control can be linked to several fans · The control can be linked to several fans
- 2 Tamaños diferentes de tijas**
2 Size of rods · 2 Taille de tiges · 2 Stabgröße · 2 dimensioni delle aste
- Grado de protección IP44**
Degree of protection · Niveau de protection · Grado di protezione · Schutzart
- Apto para exterior: IP44**
Suitable for outdoor use: IP44 · Adapté à l'utilisation en extérieur: IP44 · Geeignet für den Außeneinsatz: IP44 · Adatto all'uso esterno: IP44
- Flujo de aire amplio**
Ample airflow · Débit d'air important · Reichlich Luftstrom · Ampio flusso d'aria

Kit Luz (3000K-4000K-6500K)
Light Kit · Kit d'éclairage · Bausatz Licht · Kit luci

Control de pared
Wall control · Commande murale · Wandsteuerung · Comando a parete

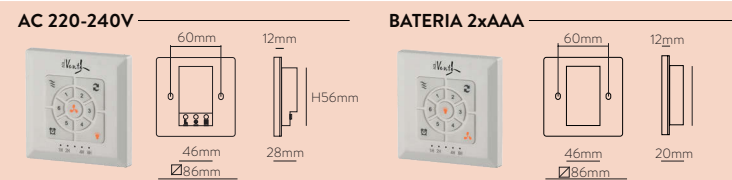

GRADO DE PROTECCIÓN

Degree of protection / Niveau de protection / Grado di protezione / Schutzart

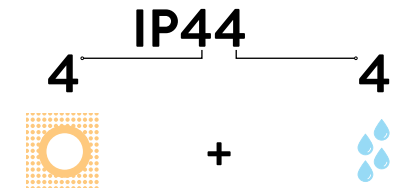
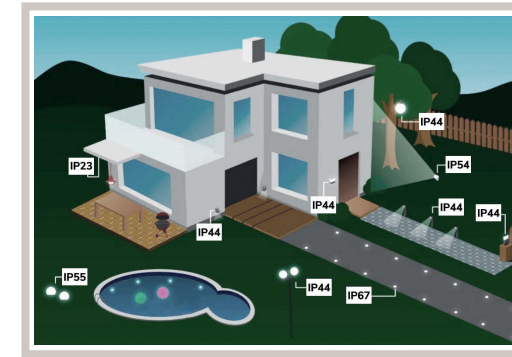

Índice de protección contra la penetración de partículas sólidas y húmedas
Protection degree offered by the fixture to the ingress of solids and liquids
Indice de protection contre la pénétration des corps solides et des liquides
Indice di protezione contro la penetrazione di corpi solidi e di liquidi
Schutzgrad gegen feste Fremdkörper und Wasser

| | 1a cifra, protección contra la penetración de cuerpos sólidos | 1st figure, protection against penetration by solid bodies | 1er chiffre, protection contre la pénétration de corps solide | 1a cifra, protezione contro la penetrazione dei corpi solidi | 1. Kennziffer: Schutz gegen Eindringen fester Körper |
|----------|--|--|---|---|--|
| 0 | Ninguna protección | No protection | Sans protection | Nessuna protezione | Ungeschützt |
| 1 | Protección contra cuerpos sólidos de tamaño superior a 50mm | Protected against solid bodies over 50 mm in diameter | Protection contre les corps solides de dimensions supérieures à 50 mm | Protezione contro i corpi solidi di dimensioni superiori a 50mm | Fremdkörper grösser als 50 mm |
| 2 | Protección contra cuerpos sólidos de tamaño superior a 12mm | Protected against solid bodies over 12 mm in diameter | Protection contre les corps solides de dimensions supérieures à 12 mm | Protezione contro i corpi solidi di dimensioni superiori a 12mm | Geschützt gegen feste Fremdkörper grösser als 12 mm |
| 3 | Protección contra cuerpos sólidos de tamaño superior a 2,5mm | Protected against solid bodies over 2,5 mm in diameter | Protection contre les corps solides de dimensions supérieures à 2,5 mm | Protezione contro i corpi solidi di dimensioni superiori a 2,5mm | Geschützt gegen feste Fremdkörper grösser als 2,5 mm |
| 4 | Protección contra cuerpos sólidos de tamaño superior a 1mm | Protected against solid bodies over 1 mm in diameter | Protection contre les corps solides de dimensions supérieures à 1 mm | Protezione contro i corpi solidi di dimensioni superiori a 1mm | Geschützt gegen feste Fremdkörper grösser als 1 mm. |
| 5 | Protección contra el polvo | Protected against dust | Protection contre les poussières | Protezione contro la polvere | Staubgeschützt. |
| 6 | Totalmente protegido contra el polvo | Fully protected against dust. | Totalement protégé contre les poussières | Totalmente protetto contro la polvere. | Staubgeschützt. |
| | 2a cifra, protección contra la penetración de agua | 2nd figure, protection against water infiltration | 2ème chiffre, protection contre l'infiltration d'eau | 2a cifra, protezione contro l'infiltrazione di acqua | 2. Kennziffer: Schutz gegen Wassereintritt |
| 0 | Ninguna protección | No protection | Sans protection | Nessuna protezione | Ungeschützt |
| 1 | Protección contra caída vertical de gotas de agua | Protected against drops of water falling vertically | Protection contre les chutes verticales de gouttes d'eau. | Protezione contro la caduta in verticale di gocce d'acqua | Geschützt gegen senkrecht fallendes Tropfwasser. |
| 2 | Protección contra caída vertical de gotas de agua, 15° máx. inclinación | Protected against drops of water at a max. inclination of 15 degrees | Protection contre les chutes verticales de gouttes d'eau avec angle d'inclinaison max. de 15° | Protezione contro la caduta in verticale di gocce d'acqua con angolo di inclinazione max di 15° | Geschützt gegen schräg fallendes Tropfwasser mit einem Winkel bis zu 15° |
| 3 | Protección contra caída vertical de gotas de agua, 60° máx. inclinación | Protected against drops of water at a max. inclination of 60 degrees | Protection contre les chutes verticales de gouttes d'eau avec angle d'inclinaison max. de 60° | Protezione contro la caduta in verticale di gocce d'acqua con angolo di inclinazione max di 60° | Geschützt gegen schräg fallendes Tropfwasser mit einem Winkel bis zu 60° |
| 4 | Protección contra salpicaduras de agua procedentes de todas direcciones. | Protection against splash water from all directions. | Protection contre les projections d'eau provenant de toutes les directions. | Protezione contro gli spruzzi d'acqua provenienti da tutte le direzioni. | Schutz gegen Spritzwasser aus allen Richtungen. |
| 5 | Protección contra chorros de agua. | Protected against jets of water | Protection contre les projections d'eau. | Protezione contro i getti d'acqua | Geschützt gegen Strahlwasser. |
| 6 | Protección contra olas de agua | Protected against waves | Protection contre les vagues d'eau. | Protezione contro le ondate d'acqua | Geschützt gegen Seewellen |
| 7 | Protección contra inmersión | Immersion protected | Protection contre l'immersion | Protezione contro l'immersione | Eintauchgeschützt |
| 8 | Protección contra inmersión prolongada | Protected against long term immersion | Protection contre l'immersion prolongée. | Protezione contro l'immersione prolungata. | Geschützt gegen dauerhaftes Eintauchen |



Toda la información en este catálogo sirve simplemente como una indicación y no es vinculante para la empresa. La empresa se reserva el derecho de modificar o variar los productos para mejoras técnicas o estéticas sin previo aviso. Las marcas y los logotipos pertenecen a sus legítimos propietarios.

All information in this catalogue merely serves as an indication and it is not binding for the company. The company reserves the right to modify any contents or information, even without prior notice. Brand names and logos belong to their legitimate owners.

Toutes les informations contenues dans ces catalogues ont une valeur indicative, et ne s'entendent pas contraignantes pour l'entreprise. La société se réserve le droit de modifier tout contenu ou information, en y apportant des améliorations techniques et visuelles, y compris sans communication préalable. Les marques et logos sont propriété de leurs dépositaires légitimes.

Alle Angaben in diesem Katalog dienen lediglich als Hinweis und sind für das Unternehmen nicht verbindlich. Das Unternehmen behält sich das Recht vor, Inhalte oder Informationen auch ohne vorherige Ankündigung zu ändern, um technische oder ästhetische Verbesserungen zu erreichen. Markennamen und Logos gehören ihren rechtmäßigen Eigentümern.

Tutte le informazioni presenti in questo catalogo sono soltanto indicative e non sono vincolanti per l'azienda. La società si riserva il diritto di modificare o effettuare variazioni sui prodotti per miglioramenti tecnici o estetici senza preavviso. I marchi e i loghi appartengono ai legittimi proprietari.

Los diseños que contiene este catálogo de la empresa española con CIF B96498233, están registrados y protegidos por la Ley de Protección de Diseño Industrial.

All designs included in this catalogue from the Spanish Company with CIF B96498233, being registered and protected by the Industrial Design Protection Law.

© Copyright. 2024 CIF B96498233



Vento pdf

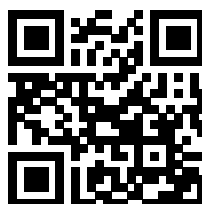

<https://acb.lighting>

NACIONAL

TEL.: +34 962 779 021
comercial@acbiluminacion.com

EXPORT

TEL.: +34 962 779 166
export@acbiluminacion.com

ACB *Vento*



8 430390 381410

V2 01-21

ACB ILUMINACION, S.L.

Camino de valencia 104, CP. 46190, Ribarroja del Turia (Valencia) España.

<https://acb.lighting>