

New Products
Supplements
Complete Overview



Uniscan

Invia light structure



Invia 48V

modular light structure –
from New Work office to
museum

Lines lend dynamism to architecture and emphasise spatial dimensions. ERCO combines the continuous line with a fully comprehensive toolbox of light distributions. This makes Invia 48V a light structure that impresses as a linear design element and fulfils any lighting task.

p. 6

www.erco.com/invia-site



Uniscan

The spotlight for galleries with the highest standards

Perfectly displayed art. Interchangeable light distributions, the magic ERCO Darklight lens, tunable white and control via radio make Uniscan versatile in use. The simple form blends discreetly into any exhibition concept.

p. 38

www.erco.com/uniscan-site

Product supplements

in the ERCO indoor and outdoor range



Tesis ground-recessed luminaires, now in a minimum size of only 56mm diameter.

p. 54

www.erco.com/tesis



Now control ground-recessed luminaires outdoors via Bluetooth with the Casambi DALI Gateway.

p.55



Atrium double focus with silver anti-glare cone, ideal for bright ceilings.

p. 56

www.erco.com/atrium-df



With Casambi sensors for track you control light via Bluetooth in a particularly sustainable way.

p. 58

www.erco.com/casambi



ERCO projects

Whether ancient monuments, extraordinary museums, modern working environments or public buildings: ERCO offers professional lighting tools for indoor and outdoor applications.

Digterlunden Park, Copenhagen
Light only where it is needed. The Castor bollard luminaire with innovative optical system creates ideal path lighting and visual guidance – the light is directed exclusively onto the ground. Photography: Johan Elm



Learn more about our international projects in our reports and background projects:

www.erco.com/projects



Nvidia, Santa Clara/USA
 The design of NVIDIA's headquarters in Santa Clara focuses on the employees. Generous green walls illuminated with Stella ensure a high quality of stay and a good indoor climate. Photography: Jason O'Rear



CapitaSpring, Singapore
 This new, 280m high, high-tech green-planted skyscraper seems to open itself up to the viewer: The trees integrated into the facade concept are visually highlighted by ERCO Tesis recessed luminaires.

Photography: Raphael Olivier
 Lighting design: Nipek Pte Ltd
 Architecture: BIG Bjarke Ingels Group + Carlo Ratti Associati





Las Vegas Convention Centre, Las Vegas
 Kona outdoor spotlights illuminate the vast projecting roof canopy from below, giving it a light, almost floating impression. The light creates a connection between the interior and exterior: visitors are given a welcoming reception.
 Architecture: TSK Architects
 Lighting design: CM KLING + ASSOCIATES
 Photography: Ryan Linton



Aurora Museum, Shanghai
 Wallwashing with high uniformity is not only suitable for illuminating works of art, it also creates a prestigious spatial impression. As in the Aurora Museum in Shanghai, designed by Tadao Ando.
 Architecture: Tadao Ando
 Lighting design: Kilt Planning Office Inc.
 Photography: Jackie Chan

Munch Museum, Oslo
 This museum in the Norwegian artist's birthplace houses the world's largest collection of works by Edvard Munch. Illuminated with ERCO Parscan and Eclipse spotlights.
 Architecture: estudioHerreros, Madrid
 Lighting design: ZENISK, Oslo
 Photography: Tomasz Majewski



**La Samaritaine,
Paris**
Illumination from
great heights and
accentuation of
a beautiful Art
Deco decorative
frieze through
large-scale, uni-
form wallwash-
ing; Parscan
makes the La
Samaritaine
department store
shine in best
light.
Photography:
Anthony Perrot

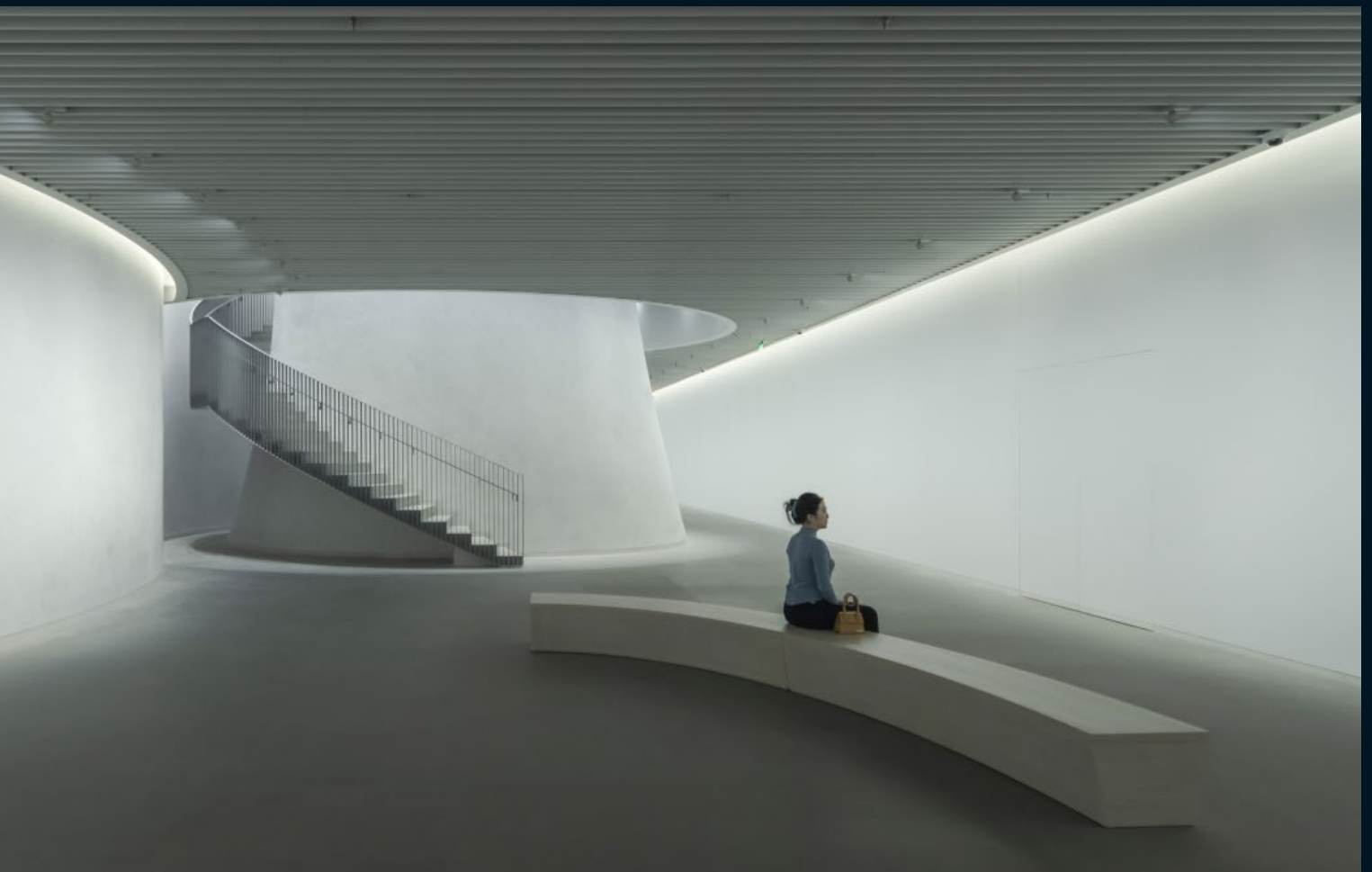



Invia 48V

The modular light structure

- Perfectly integrated: recessed, surface-mounted and pendant versions possible.
- More than just a continuous line: linear Invia downlights, uplights and wallwashers with tunable white for true Human Centric Lighting lighting concepts.
- Combine Invia with Minirail track and matching 48V spotlights for high-contrast accents.

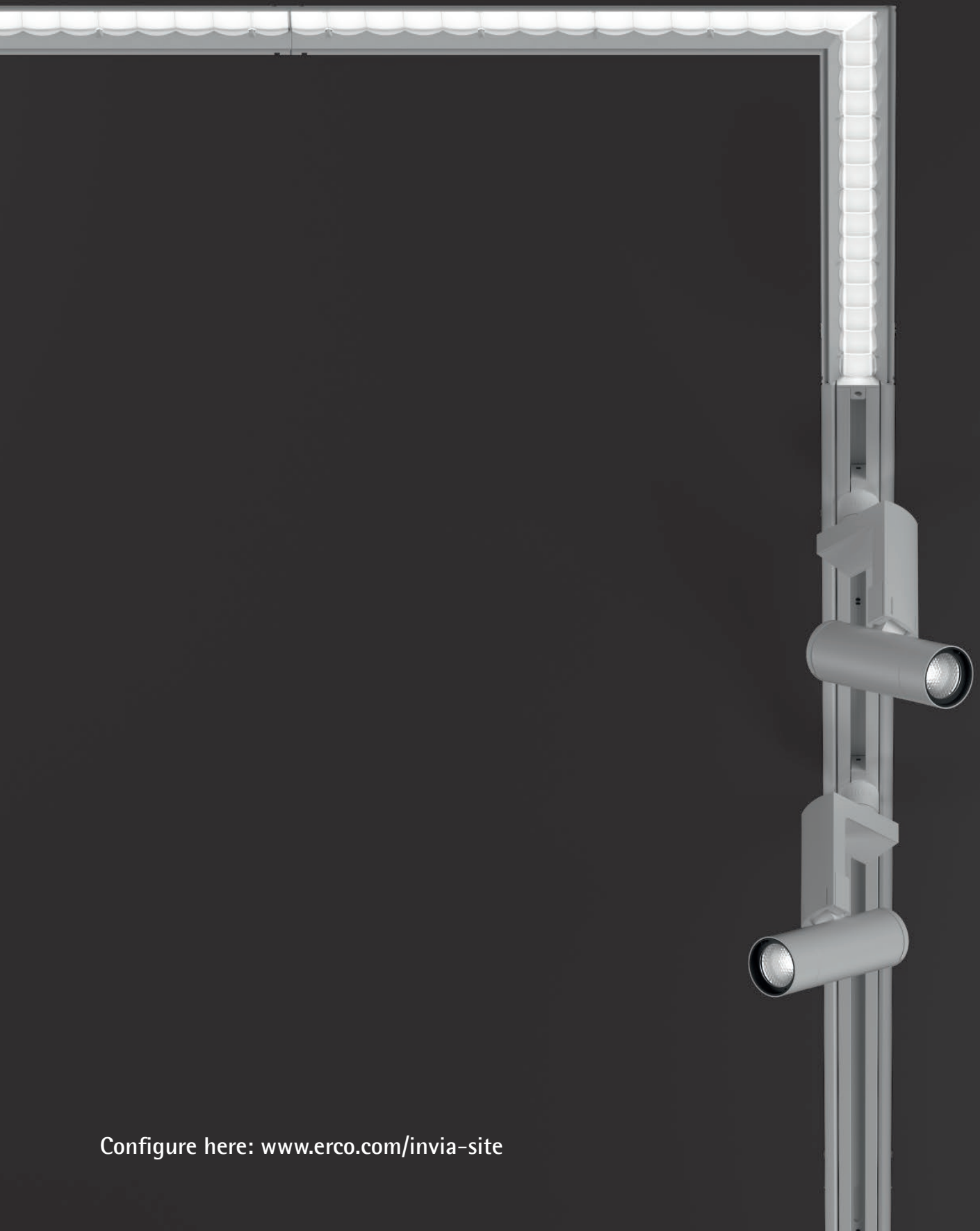

Configure here: www.erco.com/invia-site

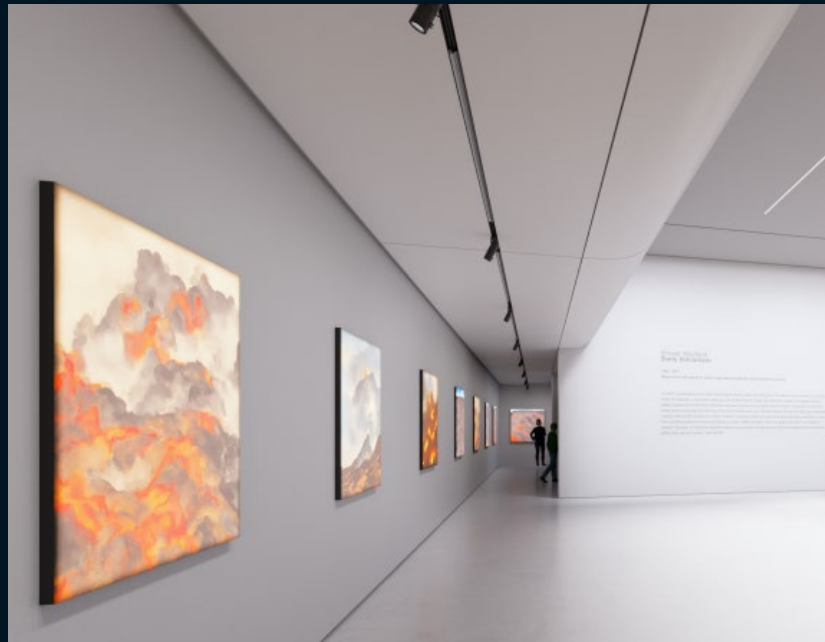

Invia 48V

Solve your lighting tasks with the continuous line that can do more

Invia 48V – modular in offices

Human Centric Lighting put into linear form. Invia 48V provides you with everything you need for perception-oriented lighting: standard-compliant general lighting with $UGR < 19$ and uplight component, tunable white and effective accent lighting with 48V spotlights.





Invia 48V – flexible in museums and galleries

Invia 48V scores with outstanding museum-quality wallwashing, even across corners – perfect for uniformly illuminating high-quality art. Art can also be displayed with high contrast thanks to the option of using 48V spotlights.



Invia 48V – integrated in public buildings

Luminaires and architecture become a single entity. Illuminate rooms up to 8m high, such as atriums and foyers, efficiently and with high visual comfort. The 70° wide flood distribution is also available in a high-output version with extra high luminous flux.



Configure here:
www.erco.com/invia-site

Invia 48V

The line follows the architecture.
The light follows the application.

Lines lend dynamism to architecture and emphasise spatial dimensions. ERCO combines the continuous line with a fully comprehensive toolbox of light distributions. This makes Invia 48V a light structure that is impressive as a linear design element and fulfils any lighting task.

Work

EN12464 compliant for offices and circulation zones

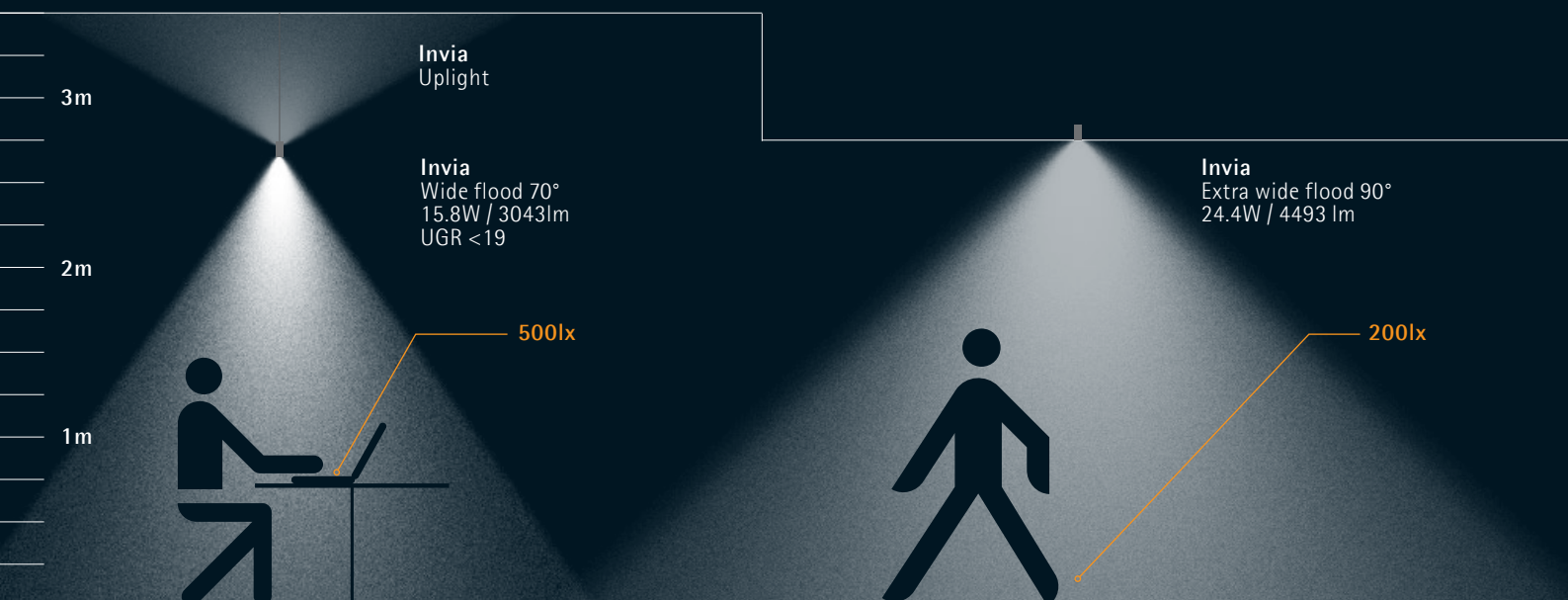

Invia light distributions
 The right light distribution from the line for every application. If you wish, also with tunable white.

Downlights		Wallwasher		Uplight	
	Wide flood 70° UGR < 19		Wallwash		Diffuse
	Wide flood 70° High output				
	Extra wide flood 90°				
	Diffuse				

Community

for atriums and foyers



Diffuse light for line guidance at any room height

Culture

for exhibitions

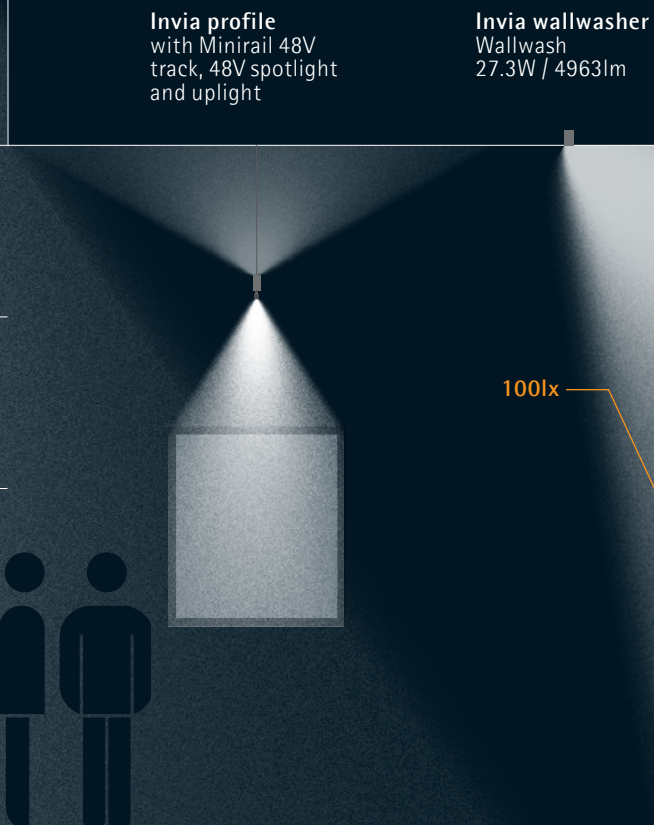

Invia 48V as linear wallwasher, in this configuration is ideal for museums and galleries



 **Spatial perception**
Wallwash

 **Accent lighting**
48V spotlight

 **Light colour**
Tunable white (2700K–6000K)

 **Control**
Casambi Bluetooth

**You have a different lighting task?
Simply adapt Invia 48V.**



Would you like to emphasise the lines of the architecture?

The linearity of the diffuse distribution downlight is the right choice if you wish to mainly emphasise the dynamism of the architecture.

DALI

Would you prefer to control with DALI?

With DALI, you get a proven light management system for your Invia 48V continuous line. Thanks to the DALI version, Invia 48V can be easily integrated into the light control system.



Pendant with uplight

Wire ropes or pendant tubes as accessories enable you to suspend the Invia 48V surface-mounted profile from the ceiling. The optionally available uplight brightens the ceiling to additionally emphasise the impression of the high room.

Configure here: www.erco.com/invia-site



Invia 48V with linear downlights,
in this configuration ideal
for public buildings



General lighting

Wide flood 70° (high output downlight)



Light colour

4000K

DALI

Control

DALI controllable

You have a different lighting task? Simply adapt Invia 48V.



Would you like to uniformly illuminate high walls?

With Invia 48V wallwashers you create a wide spatial impression thanks to linear vertical lighting – even across corners.



Are you looking for a pragmatic mounting solution?

The surface-mounted and pendant versions are particularly suitable for projects in existing buildings. The suspended profile is also available with indirect light emission.



Would you like to emphasise architectural elements or room zones?

Create perceptual hierarchies through accent lighting. Invia 48V can be combined with our Minirail track and all our 48V spotlights – from 5° narrow spot right up to zoom spotlight.

Configure here: www.erco.com/invia-site





Invia 48V with UGR<19
downlights, in this configuration
ideal for offices



General lighting
Wide flood 70° (UGR<19 downlight)



Accent lighting
48V spotlight



Light colour
Tunable white (2700K–6000K)



Control
Casambi Bluetooth

**You have a different lighting task?
Simply adapt Invia 48V.**



Is a wide spatial impression particularly important to you?
Linear vertical illumination is the prime discipline of Invia 48V wallwashers. They project light with a unique level of uniformity even across corners and with tunable white.



Would you like to integrate Invia 48V ideally into the architecture?
The two recessed variants for flush and covered mounting mean that you can integrate Invia 48V ideally into your office architecture.

DALI **Would you like to use classic light management?**
Invia is a 48V continuous line that can be controlled via DALI. This means that each luminaire can be addressed individually.

Configure here: www.erco.com/invia-site

Invia 48V: real Human Centric Lighting as it should be



UGR < 19

Architecture: light for high quality of stay and good orientation

The interplay of light and form influences our perception of architecture. Illuminated vertical surfaces in particular are vital for orientation and the impression of brightness. As a linear wallwasher, Invia 48V is perfect for this. The addition of linear downlights and spotlights thus creates coordinated architectural lighting.

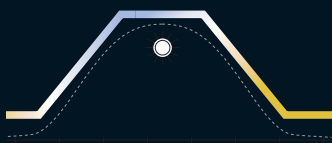

Atmosphere: the right light for any time of the day

Invia 48V features tunable white with all light distributions. This allows you to adapt the course of daylight and create temporal orientation in the interior thanks to dynamic light scenes. Whether controlled individually by radio (Casambi Bluetooth) or via the building technology (DALI), you always create the right atmosphere.

Activity: visual comfort for any task

Make high visual comfort the fundamental principle of your lighting design by using luminaires that meet the highest requirements for perfect glare control. Invia 48V, with good light, supports both interpersonal communication and concentrated work.

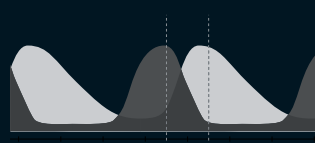

Use the melanopic efficacy of light

Light controls our sleeping and waking rhythm. In addition to the spectrum and brightness, the direction from which the light falls on the retina in the eye is significant. Light reflected from walls and the ceiling is particularly effective. Invia 48V offers wallwashers and uplights directed towards the ceiling as well as tunable white-variable light colours for all luminaires.





Perfect wallwashing.

Endless, even around corners.

Illuminated walls significantly determine the effect of the architecture and the impression of brightness in the room. Because illuminated walls are perceived as being disproportionately brighter than horizontal lighting, a lower illuminance is required to achieve an identical impression of brightness. Invia 48V linear wallwashers illuminate vertical surfaces particularly effectively and achieve excellent uniformity, even across corners.

Invia 48V wallwashers provide

- Seamless museum-quality wallwashing, even across corners
- 40% less energy consumption than comparable wallwashers
- Linear luminaire arrangements for excellent horizontal and vertical uniformity
- Ideal visual comfort thanks to very good shielding



Dynamic. Wallwashing with tunable white

Always illuminating art or architecture with the right light. For this purpose, ERCO has developed wallwashers that, thanks to tunable white, can adjust the colour temperature from 2700K to 6000K with CRI 92 across all light colours. This enables you to coordinate your lighting to the colour schemes of exhibits or adjust the light to the course of daylight.

Excellent visual comfort

The wallwashers are designed so that no direct view into the luminaire is possible from the room side.

The light emission surface directed towards the wall thus ensures very high visual comfort.

For uniform vertical lighting, the distance to the wall (a) of Invia wallwashers should be at least one third of the room height (h).



Perfect uniformity: in all directions and across corners

The most important quality feature for excellent wallwashing is uniformity. In addition to perfect horizontal uniformity, Invia 48V as a linear wallwasher also achieves a very natural brightness gradient in the vertical. With a uniformity of 1:2.3 from minimum to maximum, Invia 48V is significantly above the standard of 1:4. The light starts directly below the ceiling and falls uniformly over the entire height of the wall.

The advantage: intelligently designed 90° corner wallwashers ensure seamlessly uniform illumination even across corners.

h

a



**1.2W/m²
per 100lx**

Effective wallwashers

In addition to design requirements, economic factors are also important with wallwashing. Invia wallwashers, with up to 107lm/W, are especially efficient. The precise optical system ensures that the luminaires project their light particularly uniformly and extremely effectively onto the target surface. On a 3m high wall, Invia 48V sets the effectiveness benchmark for linear wallwashing with 1.2W/m² per 100lx.

Precise lens technology

Invia 48V luminaires



Light control with high visual comfort

Projection instead of reflection. The miniaturised lens system with a width of only 2.5cm projects light precisely onto the target surface.

This makes Invia 48V particularly effective in application. Special wide flood (70°) downlights allow different applications: illuminate office workstations with UGR < 19 and high visual comfort. Downlights in high-output versions are available for high rooms.

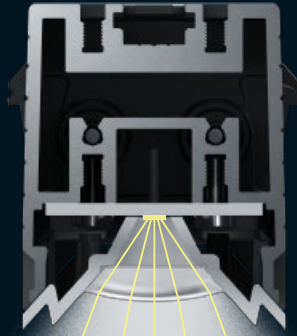

For perfect uniformity, Invia 48V uses an optical system consisting of a light mixer and lens. The light mixer features extremely high reflectivity and directs 95% of the light into the lens.

The lens system, developed in-house and manufactured by ERCO, directs the light precisely and generates different light distributions.

	2700K CRI 92
	3000K CRI 82
	3000K CRI 92
	3500K CRI 92
	4000K CRI 82
	4000K CRI 92
	Tunable white

6 spectra and tunable white

Create the right atmosphere: 6 white light spectra from 2700K to 4000K and CRI 82 to CRI 92 are available. For dynamic lighting concepts such as Human Centric Lighting, you can use tunable white from 2700K to 6000K to adapt the light colour of downlights, uplights and wallwashers to daylight.

Invia light distributions

The right light distribution from the line for every application. If you wish, also with tunable white.

Downlights		Wallwasher	Uplight		
	Wide flood 70° UGR < 19		Wallwash		Diffuse
	Wide flood 70° High output				
	Extra wide flood 90°				
	Diffuse				

Control digitally.
By radio or wired.



Controllable via

DALI 

The light structure with modern connec- tivity

Invia 48V scores with digital control modes. Casambi Bluetooth enables you to operate up to 4 luminaire groups intuitively via smartphone or tablet. Complex light scenes can also be programmed and automatically called up. If you combine Invia 48V with Minirail 48V, you can also integrate the ERCO 48V Casambi sensor directly into your system. DALI is also available as a proven light management system for individually controlling single luminaires.



A single profile, many options

Integrate Invia 48V into your architecture

The integration of light within architecture is achieved to perfection with Invia 48V. Luminaires that harmonise completely with the profile create a continuous line of light to follow the lines of the architecture. Various mounting options for the profiles give you design flexibility.

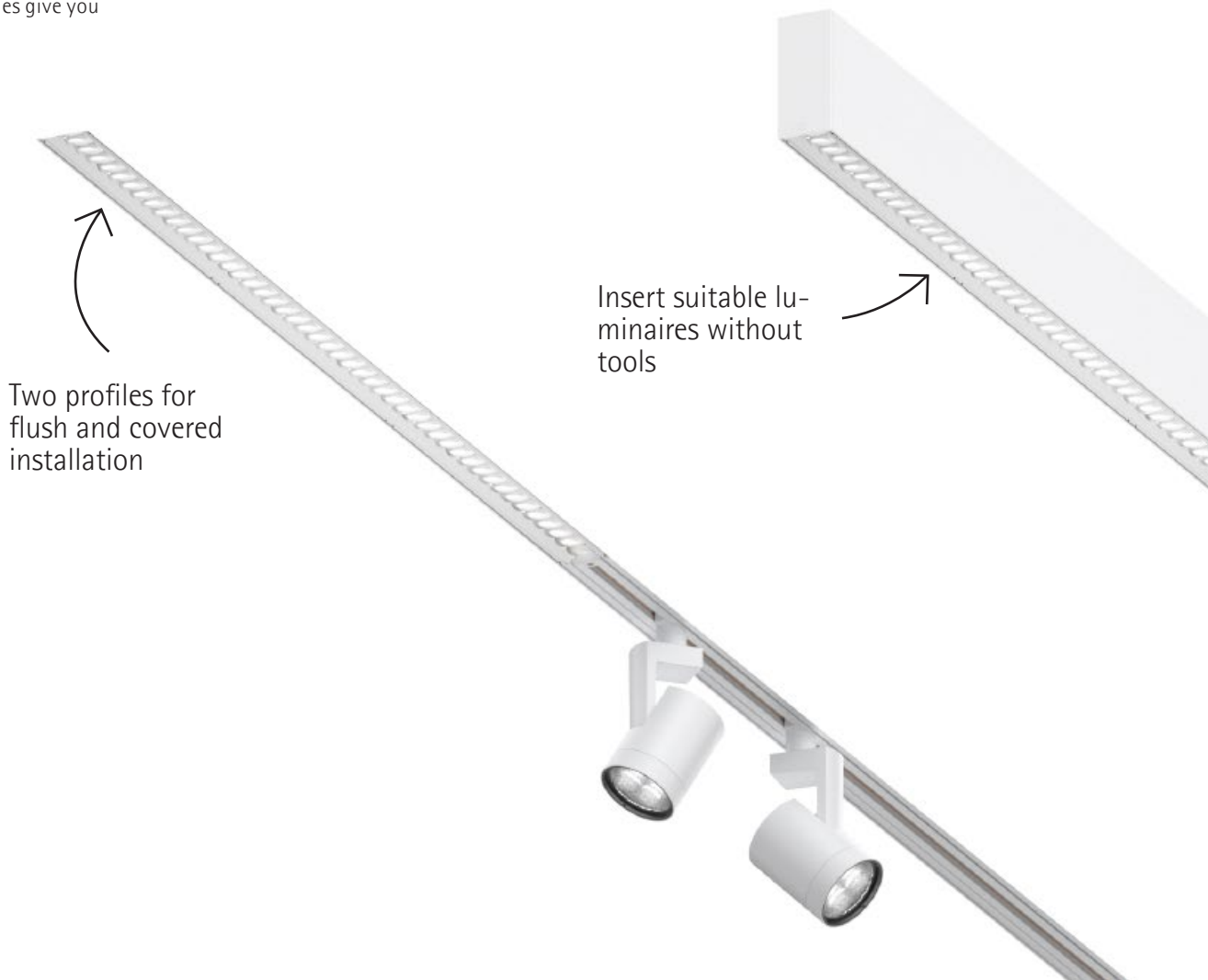

Perfectly integrated for flush and covered installation

The flanged recessed profile for acoustic panels and ceiling plates is ideal for installing in suspended ceilings. The recessed profile for flush installation is optimised for 12.5mm and 25mm ceiling thicknesses as well as the 5/8" (15mm) thickness common in the USA.

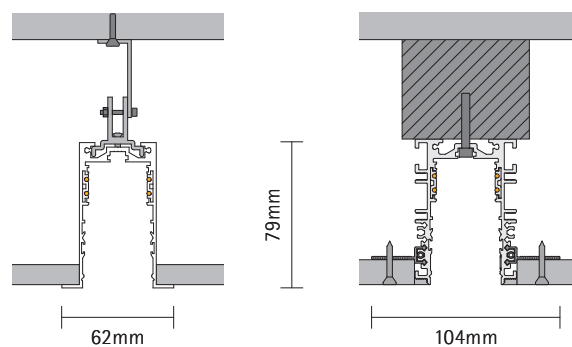



Optionally with indirect light

Pragmatic and economical: the surface-mounted variant

The surface-mounted variant is a sensible solution especially for baffle ceilings and for projects in existing buildings. The Invia 48V profile can be mounted directly on ceilings or grids.

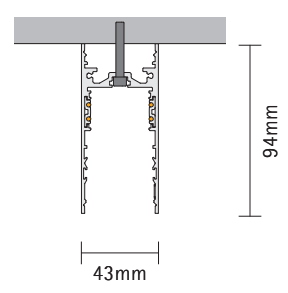

Brighten ceilings with the suspended profile

You can suspend the Invia 48V profile from the ceiling with wire ropes or pendant tubes – both types are available as accessories for the surface-mounted profile. The optionally available upright brightens the ceiling and is perfect for Human Centric Lighting concepts.

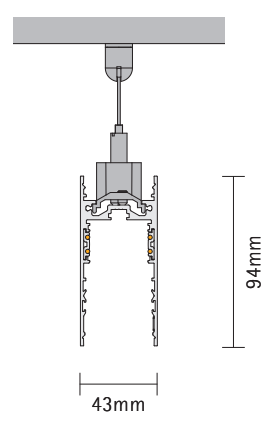

The best light structure of its kind

Invia 48V is a modular low-voltage light structure with profiles for different mounting methods, with its own linear downlights, wallwashers and optional upright. Invia 48V is also compatible with Minirail 48V track and thus all ERCO 48V spotlights.

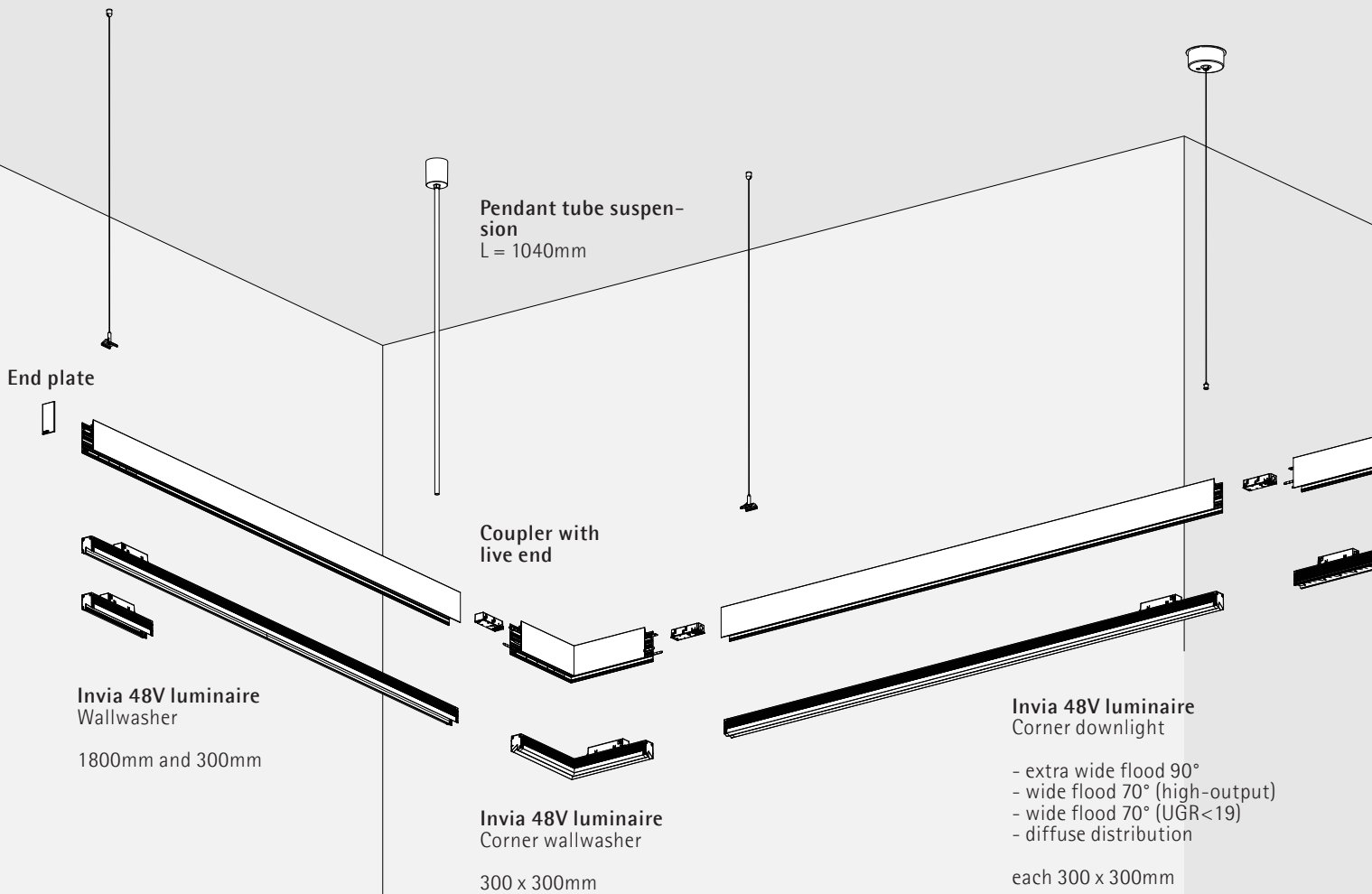

48V All profiles with 2x 48V and 2x control conductor paths

 All profiles in length 1800mm (can be shortened on site) and as a corner

Invia 48V
Corner recessed profile

300mm

Invia 48V
recessed profile

1800mm

Invia 48V
surface-mounted
profile

1800mm

Wire rope suspension
also for sloping ceilings

L = 2500mm

Uplight
for 1800mm profile

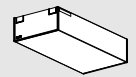

48V power
supply unit

Invia 48V luminaire
Downlight

- extra wide flood 90°
- wide flood 70° (high-output)
- wide flood 70° (UGR<19)
- diffuse distribution

each 1800mm and 300mm

Mounting kit for Minirail
48V track

900mm
can be shortened on site

Cover

1800mm
can be shortened on site

This distinguishes Invia 48V

← max. 1,8m →

1.8m spacing between suspensions

The high-quality aluminium profile enables 1.8m spacing between two suspension points.

Perfect wall-washing, even over corners

Illuminate walls more uniformly than ever – even across corners in the room.

Continuous light line

The optics of the luminaires are butted together – this creates a visually seamless continuous line for an aesthetic ceiling appearance.

Black, white, silver and 10,000 other colours

Match Invia to your architecture. Would you like a special colour?

Simply contact us. www.erco.com/individual



Linear and across corners

Configure your system from 1800mm profiles (can be shortened on site) and 300mm x 300mm corners. All luminaires are available in lengths of 300mm and 1800mm and as corner units.



1-2-click

You insert Invia 48V luminaires into the profile without tools. You can remove the luminaires from the profile in no time at all using the disassembly lever (supplied) to simply mount them at another fixing location.

How it works



Invia luminaire insert above
- Uplight (pendant version)



Invia profiles
- Flush ceiling recessing
- Covered ceiling recessing
- Ceiling surface-mounted and pendant



Invia luminaire inserts below
- Downlight wide flood 70° UGR<19 for offices
- Downlight wide flood 70° high-output for high rooms
- Downlight extra wide flood 90°
- Downlight diffuse distribution
- Wallwasher

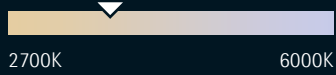

Tunable white

Each light distribution is available in tunable white. This is ideal for dynamic lighting concepts with Human Centric Lighting.



90°

70°



Downlights extra wide flood 90° for circulation zones

The wide distribution downlights illuminate circulation zones with high visual comfort.

UGR < 19

Wide flood 70° downlights for offices

Illuminate office workstations with UGR < 19 downlights.

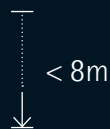

High-output downlights for high rooms

Optimally illuminate rooms with ceiling heights up to 8m. Wide flood 70° downlights with higher luminous flux are available for this purpose.

Uplight

The optionally available uplight brightens the ceiling and creates a high impression of the room – also in tunable white.



Controllable via

DALI



Smart connectivity

Invia luminaire inserts can be controlled either with DALI or with a gateway (accessory) via Casambi Bluetooth. 48V spotlights are controlled specifically via Casambi Bluetooth.



Even more possibilities with 48V luminaires

From accentuation with a 5° narrow spot to zoom optics and precise framing with tunable white and RGBW. By combining with the Minirail 48V track, you can use the full range of ERCO 48V spotlights as well as 48V sensors.



Invia profile



Live end



Mounting kit for Minirail 48V



Minirail 48V track



ERCO 48V luminaire
- Eclipse 48V
- Parscan 48V
- Uniscan 48V

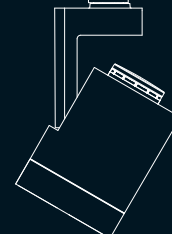

Elegant and practical

Choose the new wire rope suspension with cable gland for elegant and practical suspension from the ceiling.

Two in one

For simple planning: with Invia 48V the live end and coupler are one component. You can feed in at any coupler.

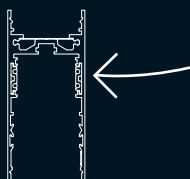
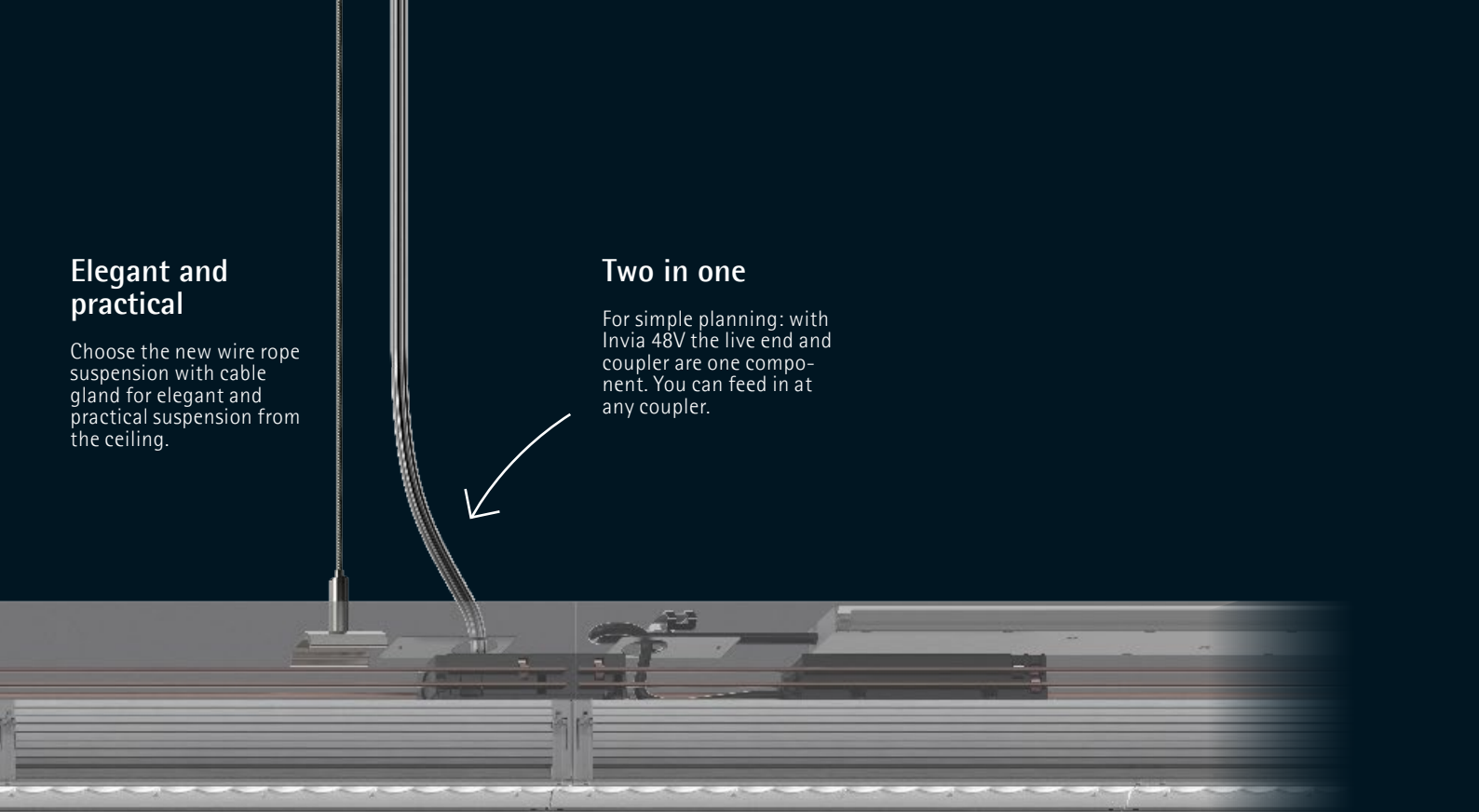

Safety class III with SELV safety extra-low voltage

Invia 48V profiles are factory configured with conductor paths for power supply and control of the luminaires.

In accordance with EN 60558-2-6, no special protective measures are required during installation.



For high electrical loads

The power supply with an external power supply unit enables electrical loads of up to 500W (2 x 250W power supply units in parallel) and profile lengths of up to 20m with only one live end.

Invia 48V is sustainable



ERCO Greenology is our holistic approach to sustainability that applies to all product ranges. Modular components and efficient lighting technology in operation distinguish Invia 48V as an especially sustainable continuous line lighting system. The possibility of replacing luminaires at a later date means you are future-proofed.

40% less energy

Effective and economical

The precise optical system of the wallwashers project the light particularly uniformly and extremely effectively onto the target surface. On a 3m high wall, Invia 48V sets the effectiveness benchmark for linear wallwashing with 1.2W/m² per 100lx and requires 40% less energy than comparable systems.

100% modular

Modularly constructed

Invia 48V is a modular continuous line system. The luminaires and electronic components developed in-house are designed for durability and low-maintenance operation. You can expand Invia 48V at any time and exchange individual components.

160lm/W efficiency

High-output downlights

48V low voltage systems are more efficient than 220-240V systems with a power supply utilisation of 30%, because the conversion from mains voltage to 48V takes place centrally and not at each individual luminaire. With up to 160 lm/W for downlights, the Invia 48V continuous line system is particularly efficient.

No adhesives

Circular economy

The Invia 48V profile has no glued joints and can be separated into its individual parts and recycled. We thus guarantee not only a very long service life but also WEEE-compliant disposal.

More light with less connected load

The optics of Invia downlights with wide flood (70°) distribution and UGR<19 not only bring the light very uniformly onto the horizontal target surface but also very effectively. For an illuminance of 500lx on the work surface in a room with 2.75m height, the connected load is only 0.48W/m² per 100lx, thus requiring 20% less energy than comparable continuous line systems. High cylindrical illuminances are also realised thanks to wide distributions, achieving very good illumination of faces.

Wide flood 70°
UGR < 19

Connected load
0.48W/m² per 100lx

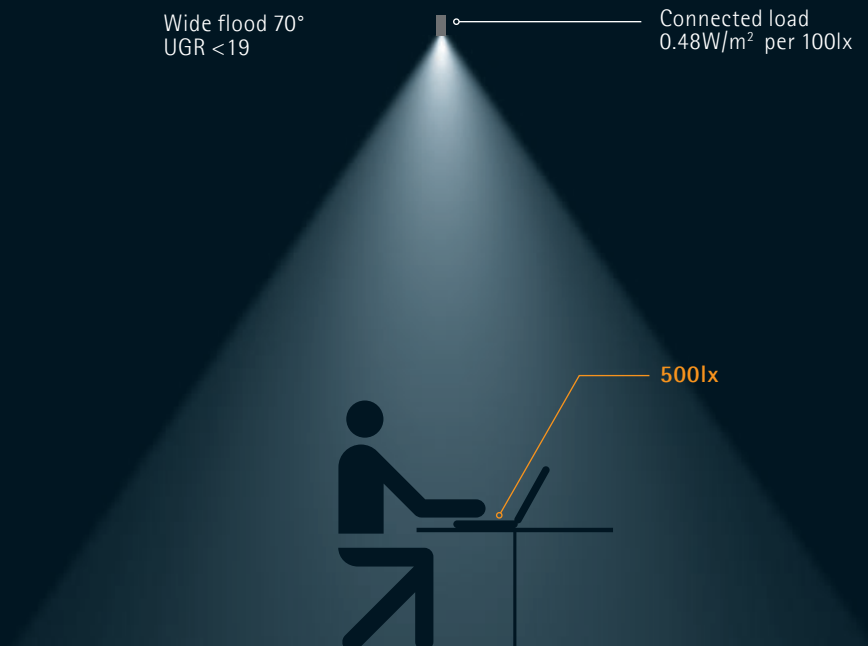

Invia 48V light structure

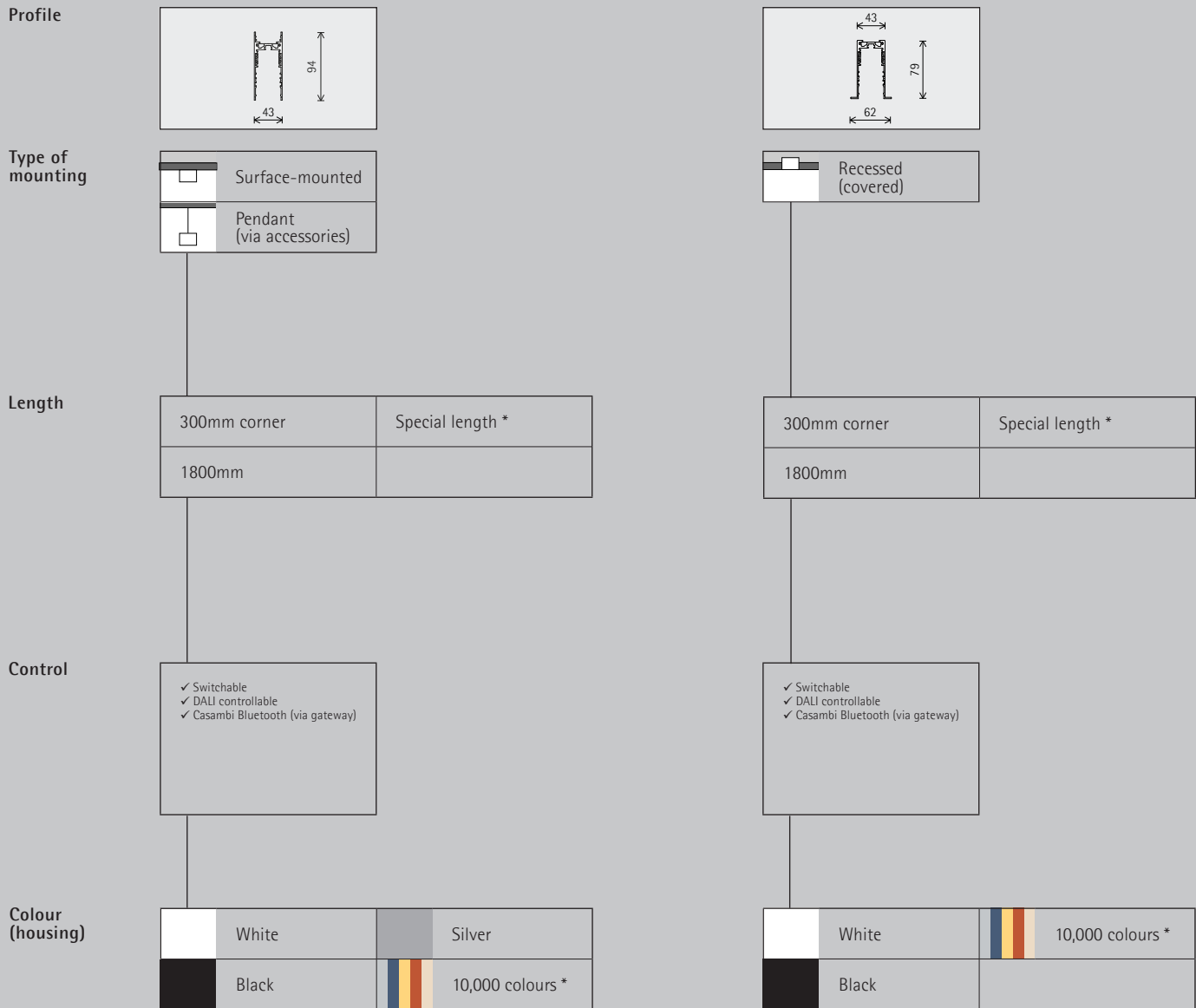

Accessories

	Mounting kit for Minirail		Suspensions		Power supply units
	Electrical connectors		Mounting devices		Casambi DALI gateway

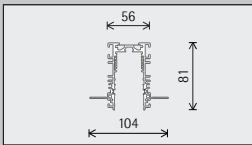

Recessed
(flush)

300mm corner	Special length *
1800mm	

- ✓ Switchable
- ✓ DALI controllable
- ✓ Casambi Bluetooth (via gateway)

* available on request

Article numbers and planning data:
www.erco.com/022544

Design and application:
www.erco.com/invia-48V



Invia 48V light structure

Size (luminaire)

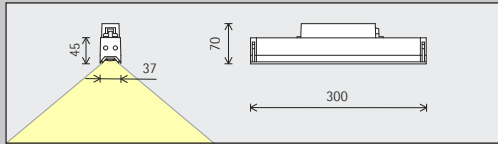

300mm

LED module
Maximum value with 4000K CRI 82

4.1W/749lm	8.2W/1498lm (corner)	5.4W/771lm	10.8W/1542lm (corner)
------------	----------------------	------------	-----------------------

Light colour

	2700K CRI 92		3500K CRI 92
	3000K CRI 82		4000K CRI 82
	3000K CRI 92		4000K CRI 92

	Tunable white
--	---------------

Downlights		Wallwasher	
	Wide flood		Wallwash
	Extra wide flood		
	Diffuse		

Downlights		Wallwasher	
	Wide flood		Wallwash
	Extra wide flood		
	Diffuse		

Control

	Switchable
	DALI controllable
	Casambi Bluetooth + DALI via Gateway

	DALI controllable
	Casambi Bluetooth + DALI via Gateway

Accessories

	Mounting kit for Minirail		Suspensions		Power supply units
	Electrical connectors		Mounting devices		Casambi DALI gateway

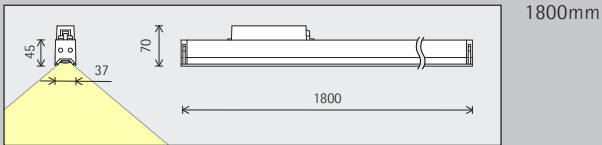

24.4W/4493lm

32.4W/4627lm

	2700K CRI 92		3500K CRI 92
	3000K CRI 82		4000K CRI 82
	3000K CRI 92		4000K CRI 92

Tunable white

Downlights		Wallwasher	
	Wide flood		Wallwash
	Extra wide flood		Uplight
	Diffuse		Diffuse

Downlights		Wallwasher	
	Wide flood		Wallwash
	Extra wide flood		Uplight
	Diffuse		Diffuse

	Switchable
	DALI controllable
	Casambi Bluetooth + DALI via Gateway

	DALI controllable
	Casambi Bluetooth + DALI via Gateway

ERCO Minirail 48V products
 Miniaturised, flexible and efficient.
 The low voltage system from ERCO
 enables high quality lighting concepts
 with extremely compact tracks
 and spotlights.

For an overview of our Minirail 48V
 luminaires as well as 48V track, visit
www.erco.com/48V

Article numbers and planning data:
www.erco.com/022544

Design and application:
www.erco.com/invia-48v





Uniscan

A minimalist and multi-talent for museums and galleries

- Perfect colour impression:
light colour with tunable white from 2700K to 7500K or RGBW is infinitely adjustable
- Control by radio:
intuitive lighting control with Casambi Bluetooth
- without complex wiring
- Compact with high-output:
three different sizes starting from a diameter of 32mm
- Future-proof:
12 interchangeable light distributions and photometric accessories for different exhibitions



**Magical
Darklight lens
for highest visual
comfort**

Interchangeable
Darklight lenses provide
maximum flexibility and
create a magical impres-
sion with just one point
of light.

This makes Uniscan the ideal spotlight for galleries



Control light with an app

Adjusting brightness and light colour or programming scenes – with Casambi Bluetooth you match the light perfectly to the exhibition.

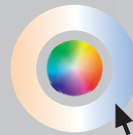
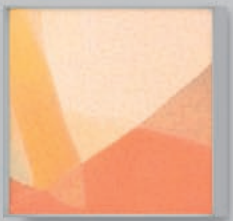

Always the right colour impression: tunable white and RGBW

Light and art in perfect unison – no problem with Uniscan. Tunable white allows you to adjust the spectrum continuously from 2700K to 7500K with CRI 92 across all light colours. RGBW offers 16 million colours and pastel shades.

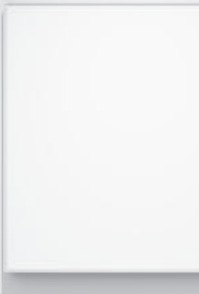

Three sizes

With luminaires in sizes from XS to M, Uniscan is equally suitable for small exhibits and large-format works of art.



Even more visual comfort with snoots and honeycomb louvres

Model the light distribution as required with accessories such as barn doors, honeycomb louvres and snoots.

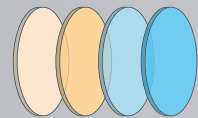

Adjusting the spectrum with filters

Modify the light spectrum with filters: create 24 further spectra using four conversion filters – perfect for temporary exhibitions.



With Connectivity interface

Dimming at the spotlight or by radio? The interchangeable add-on control unit allows you to also retroactively switch between control types.

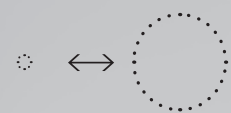
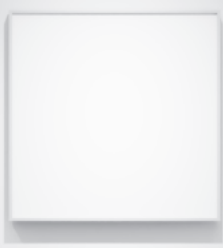
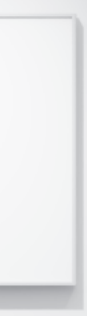

From accenting to wallwashing

Precise accentuation, crisp framing and uniform wallwashing: direct light with the maximum precision thanks to optics developed in-house.

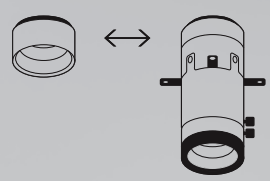

New exhibition? Exchange lenses without tools

Uniscan lens units can be changed in the blink of an eye – thus allowing flexible changing of light distributions. Also available as a contour- and zoom spotlight.



XS

Perfect for small exhibits and display cases as well as for use at very short distances up to 3m.

Ø 32mm
272lm / 2W –
382lm / 3.1W



S

Ideal for all applications in galleries and museums to a room height of 3m.

Ø 60mm
1086lm / 8.1W –
1528lm / 12.4W

Uniscan

Three sizes and three product families

Suitable for all applications – Uniscan is available in three sizes from XS to M: the spotlights thus range from a highly discreet, miniaturised size to a versatile all-rounder even for high rooms. "Light instead of luminaires" in its most discreet form, precise light distribution and flexible in the choice of beam characteristics – Uniscan is equipped for the complete diversity of gallery needs.

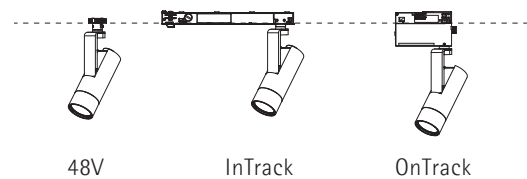



Arrange a sample now and experience Uniscan

www.erco.com/uniscan-site

M

Ideal for versatile use in galleries and boutiques with room heights up to 5m.

Ø 92mm
1901lm / 14.1W –
2673lm / 21.6W

Our recommendation for perfect gallery lighting



48V

Product range
Uniscan 48V



Light distribution
Zoom spot



Light colour
Tunable white



Control
Casambi Bluetooth

Uniscan 48V for Minirail track

Size

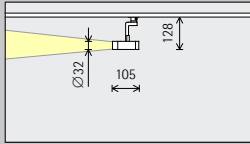

XS
Ø 32mm

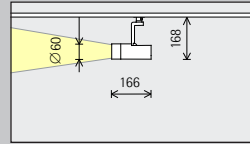

S
Ø 60mm

LED module
Maximum value
at 4000K CRI 82

2W/272lm	3.1W/382lm (Narrow spot)
3.1W/382lm	

8.1W/1086lm	3.1W/382lm (Narrow spot)
12.4W/1528lm	

Light colour

	2700K CRI 92		3500K CRI 92
	3000K CRI 92		4000K CRI 82
	3000K CRI 97		4000K CRI 92

	2700K CRI 92		3500K CRI 92
	3000K CRI 92		4000K CRI 82
	3000K CRI 97		4000K CRI 92

Light distribution

Spotlights		Floodlights	
	Narrow spot		Wide flood
	Spot		Extra wide flood
	Flood		Oval flood
	Zoom spotlights		Oval wide flood
	Zoom spot		Lens wallwashers
	Zoom oval		Wallwash

Spotlights		Floodlights	
	Narrow spot		Wide flood
	Spot		Extra wide flood
	Flood		Oval flood
	Zoom spotlights		Oval wide flood
	Zoom spot		Lens wallwashers
	Zoom oval		Wallwash
Contour spotlights			
	Narrow framing		
	Wide framing		

Control

	On-board Dim
	Casambi Bluetooth + DALI via Gateway
	Zigbee

	On-board Dim
	Casambi Bluetooth + DALI via Gateway
	Zigbee

Colour (housing)

	White		Silver
	Black		10,000 colours *

	White		Silver
	Black		10,000 colours *

Accessory

	Lenses		Lens Units		Snoot		Add-on Control Units
	Filter		Honeycomb louvre		Barn doors		DALI-Casambi Gateway

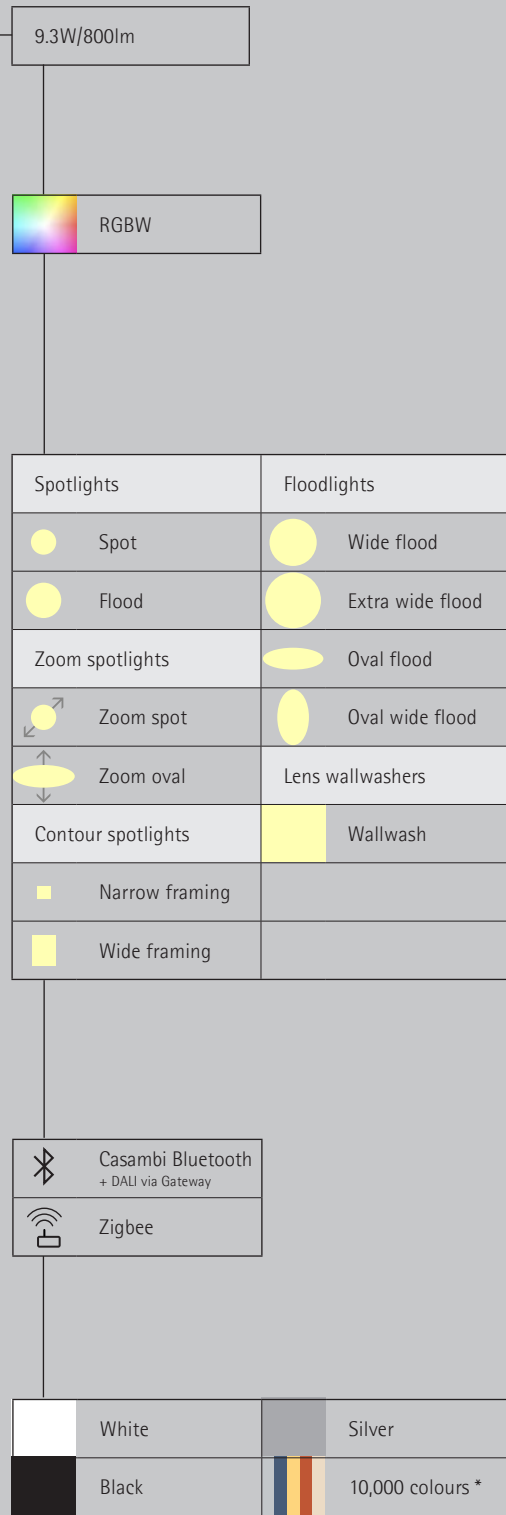
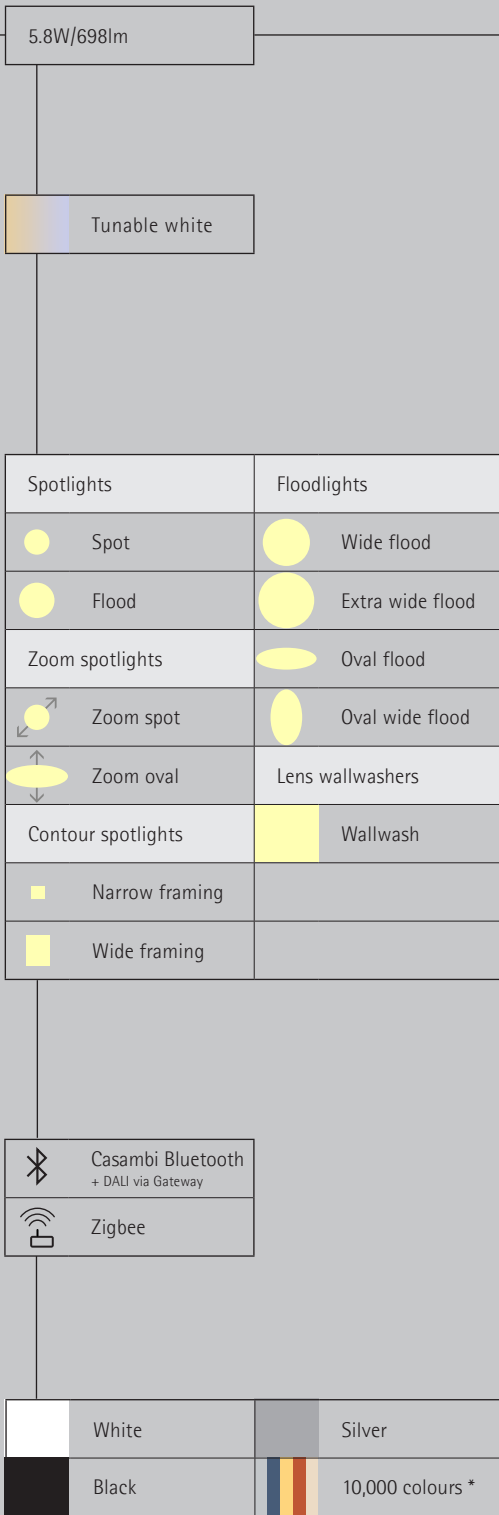

* available on request

Article numbers and planning data:
www.erco.com/022633

Design and application:
www.erco.com/uniscan-48V



Uniscan 48V for Minirail track

Size

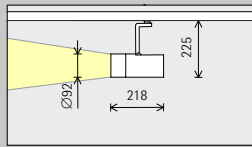

M
Ø 92mm

LED module
Maximum value at 4000K CRI 82

14.1W/1901lm	4.2W/481lm (Narrow spot)
21.6W/2673lm	

18.2W/2156lm

Light colour

	2700K CRI 92		3500K CRI 92
	3000K CRI 92		4000K CRI 82
	3000K CRI 97		4000K CRI 92

	Tunable white
--	---------------

Light distribution

Spotlights	Floodlights
Narrow spot	Wide flood
Spot	Extra wide flood
Flood	Oval flood
Zoom spotlights	Oval wide flood
Zoom spot	Lens wallwashers
Zoom oval	Wallwash
Contour spotlights	
Narrow framing	
Wide framing	

Spotlights	Floodlights
Spot	Wide flood
Flood	Extra wide flood
Zoom spotlights	Oval flood
Zoom spot	Oval wide flood
Zoom oval	Lens wallwashers
Contour spotlights	Wallwash
Narrow framing	
Wide framing	

Control

	On-board Dim
	Casambi Bluetooth + DALI via Gateway
	Zigbee

	Casambi Bluetooth + DALI via Gateway
	Zigbee

Colour (housing)

	White		Silver
	Black		10,000 colours *











	White		Silver
	Black		10,000 colours *

Accessory

	Lenses		Lens Units		Snoot		Add-on Control Units
	Filter		Honeycomb louvre		Barn doors		DALI-Casambi Gateway





17.9W/1516lm

 RGBW

Spotlights	Floodlights
 Spot	 Wide flood
 Flood	 Extra wide flood
Zoom spotlights	 Oval flood
 Zoom spot	 Oval wide flood
 Zoom oval	Lens wallwashers
Contour spotlights	 Wallwash
 Narrow framing	
 Wide framing	

 Casambi Bluetooth
+ DALI via Gateway

 Zigbee

 White	 Silver
 Black	 10,000 colours *

* available on request

Article numbers and planning data:
www.erco.com/022633

Design and application:
www.erco.com/uniscan-48V



Uniscan InTrack for track 220-240V

Size

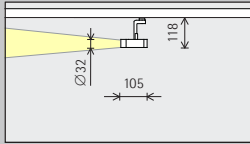

XS
Ø 32mm

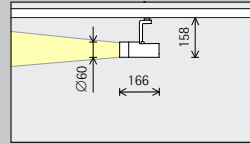

S
Ø 60mm

LED module Maximum value at 4000K CRI 82

2W/272lm	3.1W/382lm (Narrow spot)
3.1W/382lm	

8.1W/1086lm	3.1W/382lm (Narrow spot)
12.4W/1528lm	

Light colour

	2700K CRI 92		3500K CRI 92
	3000K CRI 92		4000K CRI 82
	3000K CRI 97		4000K CRI 92

	2700K CRI 92		3500K CRI 92
	3000K CRI 92		4000K CRI 82
	3000K CRI 97		4000K CRI 92

Light distribution

Spotlights	Floodlights
Narrow spot	Wide flood
Spot	Extra wide flood
Flood	Oval flood
Zoom spotlights	Oval wide flood
Zoom spot	Lens wallwashers
Zoom oval	Wallwash

Spotlights	Floodlights
Narrow spot	Wide flood
Spot	Extra wide flood
Flood	Oval flood
Zoom spotlights	Oval wide flood
Zoom spot	Lens wallwashers
Zoom oval	Wallwash
Contour spotlights	
Narrow framing	
Wide framing	

Control

Casambi Bluetooth + DALI via Gateway	Zigbee
Multi Dim ✓ DALI dimmable ✓ Push Dim ✓ Phase dimmable	Multi Dim + On-board Dim ✓ DALI dimmable ✓ Push Dim ✓ Phase dimmable ✓ Dimmable via ✓ rotary control
On-board Dim	

Casambi Bluetooth + DALI via Gateway	Zigbee
Multi Dim ✓ DALI dimmable ✓ Push Dim ✓ Phase dimmable	Multi Dim + On-board Dim ✓ DALI dimmable ✓ Push Dim ✓ Phase dimmable ✓ Dimmable via ✓ rotary control
On-board Dim	

Colour (housing)

	White		Silver
	Black		10,000 colours *

	White		Silver
	Black		10,000 colours *

Accessory

	Lenses		Lens Units		Snoot		Add-on Control Units
	Filter		Honeycomb louvre		Barn doors		DALI Casambi Gateway

5.8W/698lm

Tunable white

Spotlights	Floodlights
Spot	Wide flood
Flood	Extra wide flood
Zoom spotlights	Oval flood
Zoom spot	Oval wide flood
Zoom oval	Lens wallwashers
Contour spotlights	Wallwash
Narrow framing	
Wide framing	

Casambi Bluetooth + DALI via Gateway	Zigbee
Multi Dim ✓ DALI dimmable ✓ Push Dim ✓ Phase dimmable	Multi Dim + On-board Dim ✓ DALI dimmable ✓ Push Dim ✓ Phase dimmable ✓ Dimmable via ✓ rotary control

White	Silver
Black	10,000 colours *

9.3W/800lm

RGBW

Spotlights	Floodlights
Spot	Wide flood
Flood	Extra wide flood
Zoom spotlights	Oval flood
Zoom spot	Oval wide flood
Zoom oval	Lens wallwashers
Contour spotlights	Wallwash
Narrow framing	
Wide framing	

Casambi Bluetooth + DALI via Gateway	Zigbee
Multi Dim ✓ DALI dimmable ✓ Push Dim ✓ Phase dimmable	Multi Dim + On-board Dim ✓ DALI dimmable ✓ Push Dim ✓ Phase dimmable ✓ Dimmable via ✓ rotary control

White	Silver
Black	10,000 colours *

* available on request

Article numbers and planning data:
www.erco.com/022634

Design and application:
www.erco.com/uniscan-intrack



Uniscan InTrack for track 220-240V

Size

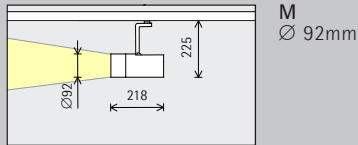

LED module

Maximum value at 4000K CRI 82

14.1W/1901lm	4.2W/481lm (Narrow spot)
21.6W/2673lm	

18.2W/2156lm

Light colour

	2700K CRI 92		3500K CRI 92
	3000K CRI 92		4000K CRI 82
	3000K CRI 97		4000K CRI 92

	Tunable white
--	---------------

Light distribution

Spotlights	Floodlights
Narrow spot	Wide flood
Spot	Extra wide flood
Flood	Oval flood
Zoom spotlights	Oval wide flood
Zoom spot	Lens wallwashers
Zoom oval	Wallwash
Contour spotlights	
Narrow framing	
Wide framing	

Spotlights	Floodlights
Spot	Wide flood
Flood	Extra wide flood
Zoom spotlights	Oval flood
Zoom spot	Oval wide flood
Zoom oval	Lens wallwashers
Contour spotlights	Wallwash
Narrow framing	
Wide framing	

Control

Casambi Bluetooth + DALI via Gateway	Zigbee
Multi Dim ✓ DALI dimmable ✓ Push Dim ✓ Phase dimmable	Multi Dim + On-board Dim ✓ DALI dimmable ✓ Push Dim ✓ Phase dimmable ✓ Dimmable via ✓ rotary control
On-board Dim	

Casambi Bluetooth + DALI via Gateway	Zigbee
Multi Dim ✓ DALI dimmable ✓ Push Dim ✓ Phase dimmable	Multi Dim + On-board Dim ✓ DALI dimmable ✓ Push Dim ✓ Phase dimmable ✓ Dimmable via ✓ rotary control

Colour (housing)

	White		Silver
	Black		10,000 colours *











	White		Silver
	Black		10,000 colours *





Accessory





	Lenses		Lens Units		Snoot		Add-on Control Units
	Filter		Honeycomb louvre		Barn doors		DALI Casambi Gateway

17.9W/1516lm

 RGBW

Spotlights	Floodlights
 Spot	 Wide flood
 Flood	 Extra wide flood
Zoom spotlights	 Oval flood
 Zoom spot	 Oval wide flood
 Zoom oval	Lens wallwashers
Contour spotlights	 Wallwash
 Narrow framing	
 Wide framing	

 Casambi Bluetooth + DALI via Gateway	 Zigbee
 Multi Dim ✓ DALI dimmable ✓ Push Dim ✓ Phase dimmable	 Multi Dim + On-board Dim ✓ DALI dimmable ✓ Push Dim ✓ Phase dimmable ✓ Dimmable via ✓ rotary control

 White	 Silver
 Black	 10,000 colours *

* available on request

Article numbers and planning data:
www.erco.com/022634

Design and application:
www.erco.com/uniscan-intrack



Uniscan OnTrack for track 220-240V

Size

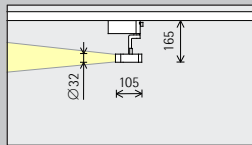

XS
Ø 32mm

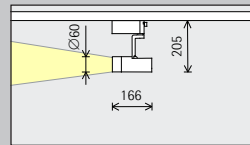

S
Ø 60mm

LED module
Maximum value at 4000K CRI 82

2W/272lm	3.1W/382lm (Narrow spot)
3.1W/382lm	

8.1W/1086lm	3.1W/382lm (Narrow spot)
12.4W/1528lm	

Light colour

	2700K CRI 92		3500K CRI 92
	3000K CRI 92		4000K CRI 82
	3000K CRI 97		4000K CRI 92

	2700K CRI 92		3500K CRI 92
	3000K CRI 92		4000K CRI 82
	3000K CRI 97		4000K CRI 92

Light distribution

Spotlights		Floodlights	
	Narrow spot		Wide flood
	Spot		Extra wide flood
	Flood		Oval flood
Zoom spotlights		Lens wallwashers	
	Zoom spot		Wallwash
	Zoom oval		

Spotlights		Floodlights	
	Narrow spot		Wide flood
	Spot		Extra wide flood
	Flood		Oval flood
Zoom spotlights			Oval wide flood
	Zoom spot	Lens wallwashers	
	Zoom oval		Wallwash
Contour spotlights			
	Narrow framing		
	Wide framing		

Control

	Phase dimmable + On-board Dim
	DALI
	Casambi Bluetooth

	Phase dimmable + On-board Dim
	DALI
	Casambi Bluetooth

Colour (housing)

	White		Silver
	Black		10,000 colours *

	White		Silver
	Black		10,000 colours *

Accessory

	Lenses		Lens Units		Snoot
	Filter		Honeycomb louvre		Barn doors

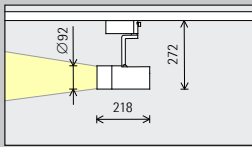

M
 Ø 92mm

14.1W/1901lm	4.2W/481lm (Narrow spot)
21.6W/2673lm	

	2700K CRI 92		3500K CRI 92
	3000K CRI 92		4000K CRI 82
	3000K CRI 97		4000K CRI 92

Spotlights		Floodlights	
	Narrow spot		Wide flood
	Spot		Extra wide flood
	Flood		Oval flood
	Zoom spotlights		Oval wide flood
	Zoom spot		Lens wallwashers
	Zoom oval		Wallwash
Contour spotlights			
	Narrow framing		
	Wide framing		

	Phase dimmable + On-board Dim
	DALI
	Casambi Bluetooth

	White		Silver
	Black		10,000 colours *

* available on request

Article numbers and planning data:
www.erco.com/022635

Design and application:
www.erco.com/uniscan-ontrack



Tesis

In-ground luminaires for outdoor spaces now available in five sizes

Tesis ground-recessed luminaires achieve particularly high levels of attention to outdoor spaces due to outstanding visual comfort. A choice of different distributions such as directional spotlights, uplights and wallwashers means you always find the right lighting tool.

www.erco.com/tesis



New: Tesis in small size

For all outdoor projects requiring very small luminaires: Tesis size 2 with only 56mm diameter achieves with 5 light distributions ranging from accentuation to uniform wallwashing.

Tesis lens wallwasher

For uniform distribution of brightness on vertical surfaces. With luminaire dimensions of only 56mm from size 2.

Reliable and robust

Tesis with IP68 protection is particularly suitable for demanding lighting tasks. Safety class II guarantees additional protective insulation of live components.

Our smallest wallwasher!

High uniformity with wallwashing – achieved with Tesis in size 2, our miniaturised wallwasher for major effects outdoors.

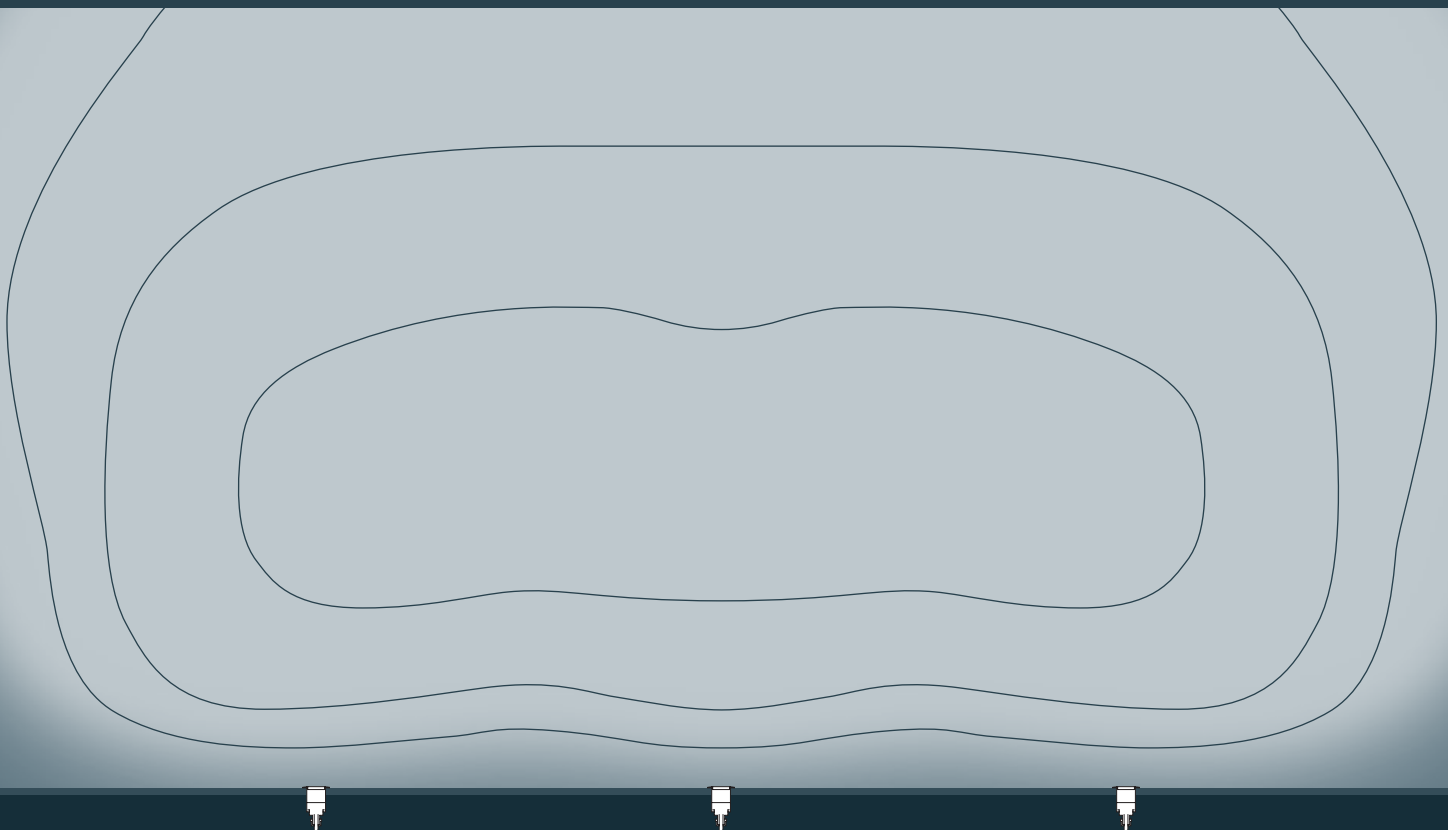
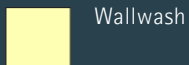

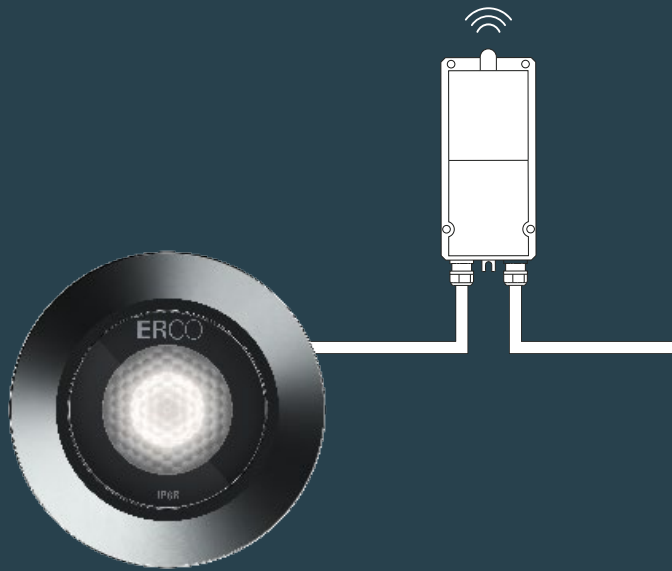

Control DALI luminaires via Casambi Bluetooth Gateway





All Tesis ground-recessed luminaires can be controlled via DALI. Program individual light scenes outdoors as well with Casambi Bluetooth via radio simply with your smartphone or tablet – no additional hardware needed.

For all wind and weather

Ground-recessed luminaires are specifically developed to meet the requirements for lighting in urban environments. The housing is made of corrosion-resistant material and is thus especially weather-proof.

Tesis directional spotlight



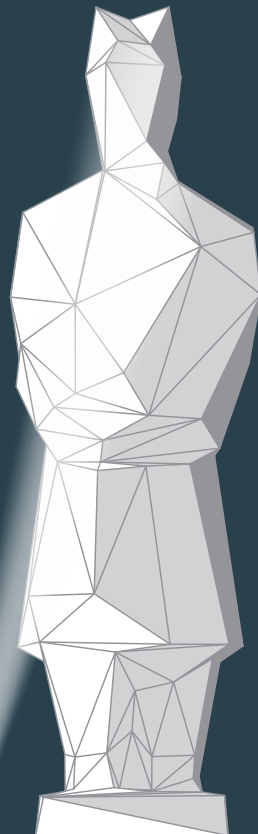

For accentuating objects, plants and architectural details.

-  Narrow spot 8°
-  Spot 16°
-  Flood 29°
-  Oval flood 20° x 60°



Tesis uplights

Uniform illumination from below for trees and overhangs.

-  Spot 16°
-  Flood 29°
-  Wide flood >45°
-  Oval flood 20° x 60°



Recessed luminaire

Seven downlight sizes mean you will always find the right lumen package for illuminating high rooms from the ceiling. Wallwashers complete the toolbox.



New!
Perfect integration into bright ceilings: anti-glare cone in silver

Atrium double focus

Sophisticated light for room heights of 6m and more

Features of the Atrium double focus range

		Atrium double focus recessed luminaires	Atrium double focus surface-mounted luminaires	Atrium double focus pendant luminaires
Application	General lighting	•	•	•
	Wallwashing	•		
Lumen packages	<1200lm	•		
	1200-3300lm	•	•	•
	>3300lm	•	•	•
Light distribution	Flood	•	•	•
	Wide flood	•	•	•
	Wallwash	•		

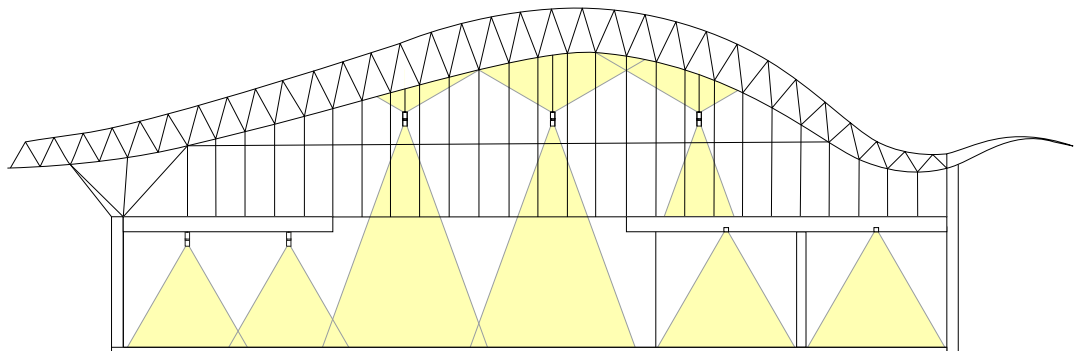



Surface-mounted luminaire

Whether with closed solid ceilings or open supporting structures – Atrium double focus surface-mounted luminaires can easily be installed to ceilings.



Pendant luminaire direct / indirect

If light should also emphasise and highlight the ceiling, Atrium double focus pendant luminaires open up new possibilities. The integrated uplight accentuates the dimension of high rooms.



Colour of choice?

Up to 10,000 further colours are available via our 'ERCO individual' service. Simply contact us.



Anti-glare cone in silver and black

Select the colour of the anti-glare cone: the black version is ideal for use in dark ceilings whilst silver looks particularly elegant and discreet in bright ceilings.



Very high visual comfort

Especially for very high rooms, ERCO has developed luminaires that feature increased visual comfort thanks to their special housing shape and high quality optical components.

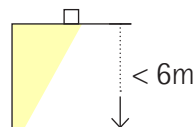

Wallwashing for high rooms

For maximum requirements with vertical lighting, ERCO has developed luminaires characterised by exceptionally high uniformity of illuminance – even at short distances to the wall.



Wired or wireless

How would you like to control Atrium? Four different control types from DALI to Casambi Bluetooth always offer the right solution.



ERCO Greenology®

Illuminate sustainably with wireless light control

Individually switching and dimming luminaires, setting up light scenes and integrating sensors – all made possible by the ERCO wireless control method in the form of Bluetooth-enabled luminaires and sensors for low voltage and high voltage track. This opens up new possibilities for sustainable lighting concepts.

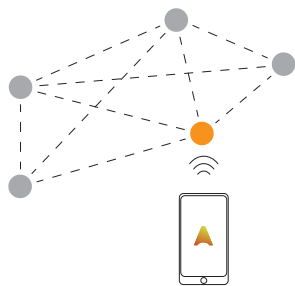

Less components due to operation via app

The Casambi app for smartphones and tablets enables luminaires to be intuitively switched and dimmed in degrees, individually or in groups. No additional hardware components or wiring are required, so the material costs and complexity are lower than with conventional control methods.

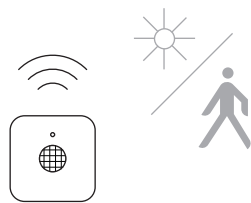

Saving energy with sensors

Minimise energy consumption by lighting only when necessary. The ERCO Casambi motion detector with light sensor enables light to be switched and dimmed depending on movement in the room or the amount of daylight. Available for mains voltage track as well as Minirail 48V.



Conserving resources with light scenes

Conveniently program time-dependent light scenes for resource-saving lighting concepts via app. Once set, the luminaires switch on and off again. Effects such as gentle fade-ins are also possible. The integrated astronomical clock also enables sustainable lighting control outdoors.



Future-proof thanks to cloud technology

Network settings are saved and synchronized across all devices. This enables high flexibility and security – even if mobile devices change. Using a gateway, you can also control your light via the internet.

Continuous operation

Light continuously at 100%.

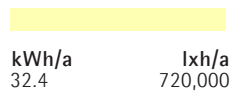
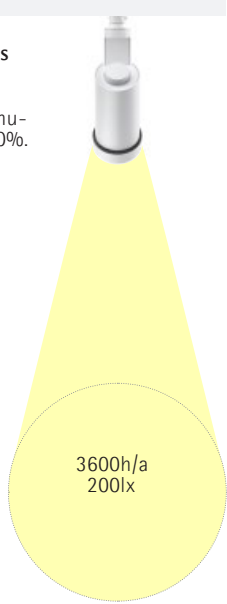

Dimmed

Light is dimmed 20% of the time.

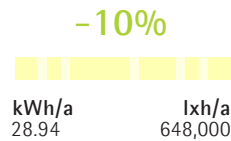
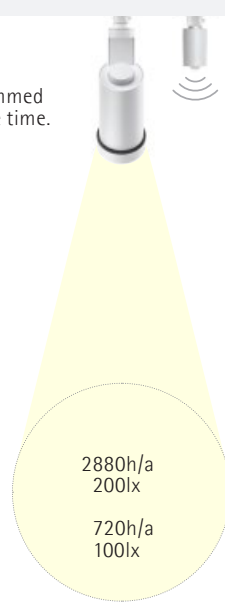

ON/OFF

Light is switched off 20% of the time.

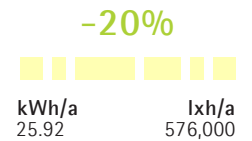
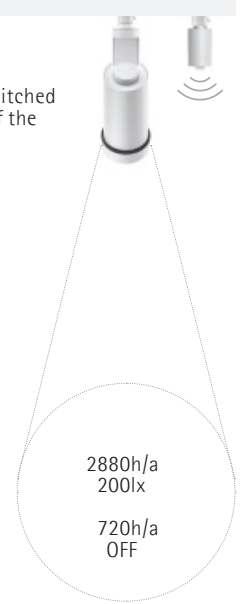

Save energy with ERCO Casambi sensors for 48V

Dimming the light or even switching it off when it is not needed – the task performed by ERCO Casambi motion detectors with light sensors. They control the lighting depending on the frequency of visitors in the room, e.g. in exhibition spaces. Compared to continuously switched on conventional lighting, energy savings of 20% or more are

achieved according to visitor frequency. Because motion detectors reduce the lighting time to the minimum required, sensitive exhibits in exhibitions are also protected in the long term.



Less equipment complexity with Casambi Bluetooth

With Casambi Bluetooth, ERCO focuses on wireless control. The effort with cabling and thus also the complexity of planning are significantly reduced. For a wireless lighting control system that, for example, is comparable to a DALI control system in terms of functionality, a 3-core instead of a 5-core connection cable is sufficient. This corresponds to material savings and cost savings of approximately 40%.

48V track



www.erco.com/track-lighting



ERCO Minirail 48V track and singlets

Miniaturised track profile

Recessed, surface-mounted or pendant mounting possible

OEM components available

220-240V track



ERCO track and singlets

Low construction height

Recessed, surface-mounted or pendant mounting possible

OEM components available



ERCO Hi-trac track with uplights

Spacing of up to four metres

Based on the proven ERCO track

Indirect lighting and OEM components available

Light structures



Invia 48V

Seamless continuous row – also around corners and with tunable white

Recessed, surface-mounted or pendant mounting possible

Downlights, wallwashers, uplight and 48V spotlights

Community, Work, Culture

Luminaires for track

Spotlights, floodlights and wallwashers for 48V track



www.erco.com/spotlights

Spotlights, floodlights and wallwashers for 220–240V track



Uniscan 48V

Miniaturised luminaire with high visual comfort

Extensive accessories as well as RGBW and tunable white

Contour spotlights and zoom spotlights available

Culture, Shop, Living



Eclipse 48V

Miniaturised luminaire with high visual comfort

Extensive accessories as well as RGBW and tunable white

Contour spotlights and zoom spotlights available

Culture, Shop



Parscan 48V

Miniaturised luminaire with high visual comfort

Extensive accessories as well as RGBW and tunable white

Contour spotlights and zoom spotlights available

Culture, Work



Uniscan InTrack

Simple design with high visual comfort

Extensive accessories as well as RGBW and tunable white

Contour spotlights and zoom spotlights available

Culture, Shop, Living



Uniscan OnTrack

Ideal for existing phase dimmable systems

Extensive accessories

Contour spotlights and zoom spotlights available

Culture, Shop

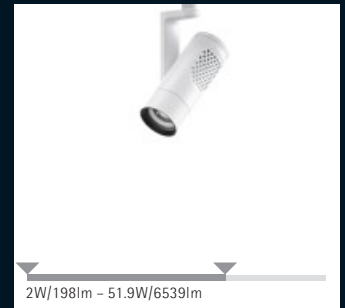

Eclipse InTrack

Five sizes and high visual comfort

Extensive accessories as well as RGBW and tunable white

Contour spotlights and zoom spotlights available

Culture, Shop, Community

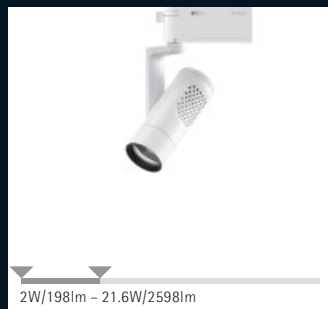

Eclipse OnTrack

Ideal for existing phase dimmable systems

Extensive accessories

Contour spotlights and zoom spotlights available

Culture, Shop, Community



Parscan InTrack

Six sizes and high efficiency

Extensive accessories as well as RGBW and tunable white

Contour spotlights and zoom spotlights available

Culture, Community



Luminaires for track

Spotlights, floodlights and wallwashers for 220–240V track



www.erco.com/spotlights



Parscan OnTrack

Ideal for existing phase dimmable systems

Extensive accessories

Contour spotlights and zoom spotlights available

Culture, Community

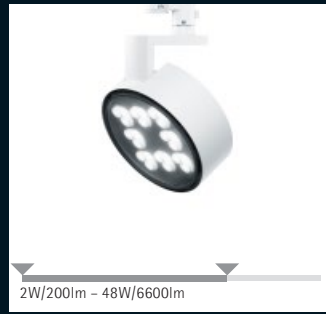

Parscan

Ideal for ceiling channels and singlets

Zoom spotlights available

Elegant design due to integrated control gear

Culture, Shop



Pollux

Compact luminaire dimensions

Contour spotlights and zoom spotlights available

Culture, Hospitality



Optec

Contour spotlights and zoom spotlights available

Pivotable through 270°

Shop, Culture



Stella

Large lumen packages for high illuminances

Ideal for high rooms

Strong accents from large distances

Community, Contemplation



Light Board

Elegant design due to integrated control gear

Suitable for singlets

Culture, Shop

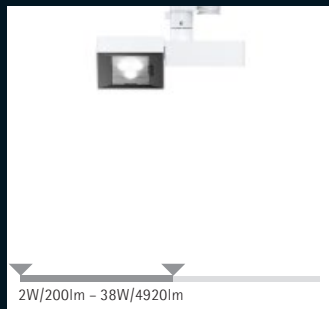

Opton

Flat luminaire design for low rooms

Two wattages per size

Shop

Luminaires for track

Downlights and wallwashers
for 220–240V track



www.erco.com/spotlights



12W/1190lm - 19W/2460lm

Skim

For office workstation lighting
as of UGR<16

Slidable downlights for flexible
office lighting

Three light distributions

Community, Work

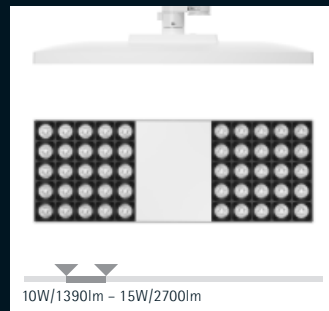

10W/1390lm - 15W/2700lm

Jilly

For office workstation lighting
as of UGR<16

Slidable downlights for flexible
office lighting

High visual comfort

Work, Community

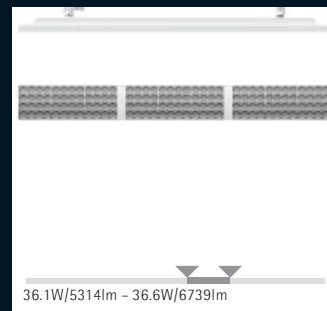

36.1W/5314lm - 36.6W/6739lm

Jilly linear

For office workstation lighting
as of UGR<16

Slidable downlights for flexible
office lighting

Suitable for high rooms <5m

Work, Community



12W/1190lm - 19W/2460lm

Compar

For office workstation lighting
as of UGR<16

Slidable downlights for flexible
office lighting

Five light distributions

Work, Community



12W/1190lm - 24W/3300lm

Pantrac

Extremely uniform wallwashing

Large luminaire spacing

Simple handling

Culture, Community

Recessed spotlights, floodlights and wallwashers

Recessed spotlights, recessed floodlights and recessed lens wallwashers



www.erco.com/spotlights-r



2W/200lm - 10W/1230lm

Starpoint

Pivotable through 30°

Six light distributions

Small luminaire dimensions

Shop, Hospitality



2W/200lm - 38W/4920lm

Gimbal

Pivotable through 40°

Seven light distributions

Gimbal suspension

Shop, Community, Culture



2W/200lm - 38W/4920lm

Gimbal with mounting bracket

Pivotable through 60°

Seven light distributions

Gimbal suspension

Shop, Community, Culture

Ceiling channel system



[www.erco.com/
spotlights-r](http://www.erco.com/spotlights-r)



Ceiling channel system

Individual dimensions possible

Ideal for recessed spotlights

Insertion plates for luminaires
available

[Shop](#)

Recessed luminaires

Downlights, wallwashers and directional spotlights



www.erco.com/
downlights-r



Quintessence round

Downlight, wallwasher and directional spotlight

Very high visual comfort due to darklight technology

Community, Work



Quintessence square

Downlight, wallwasher and directional spotlight

Very high visual comfort due to darklight technology

Community, Work

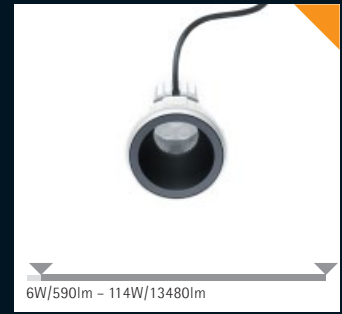

Atrium double focus

Downlights and wallwashers

Ideal for very high rooms and sloping ceilings

Very high visual comfort

Community



Iku

Downlights, wallwashers and double wallwashers

Tunable white available

Five sizes

Community, Hospitality, Work



Iku Work

Downlights with very high efficiency

For office workstation lighting as of UGR<16

Three sizes

Work



Skim

Downlights from UGR<16

Very good price performance ratio

Magically luminous lens

Community, Work



Jilly square

Downlights with low recess depth

For office workstation lighting as of UGR<16

Anti-glare louvre in various colours

Work



Compar linear

Downlights and wallwashers with extremely narrow ceiling detail

For office workstation lighting as of UGR<16

Five light distributions

Community, Work

Recessed luminaires

Grazing light wallwasher



[www.erco.com/
downlights-r](http://www.erco.com/downlights-r)



Lightgap

Impressively uniform grazing light

Concealed light source

Seamless luminaire configurations possible

Hospitality, Community

Surface-mounted luminaires

Surface-mounted downlights



www.ereco.com/downlights-s

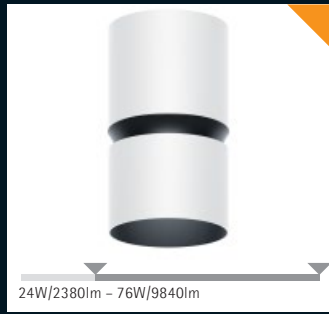

Atrium double focus

Ideal for high and very high rooms

Large lumen packages for high illuminances

Uniform general lighting with wide luminaire spacing

Community, Contemplation



Skim

For office workstation lighting as of UGR<16

Good price performance ratio

Magically luminous lens

Work

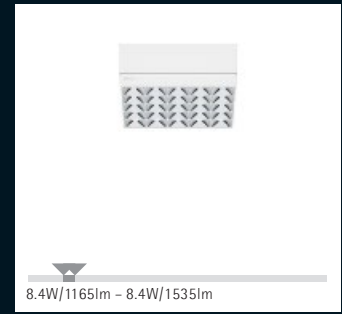

Jilly square

For office workstation lighting as of UGR<16

Anti-glare louvre in various colours

Uniform general lighting with wide luminaire spacing

Work



Jilly linear

For office workstation lighting as of UGR<16

Anti-glare louvre in various colours

Very high visual comfort for working

Work



Compar square

For office workstation lighting as of UGR<16

Three power ratings

Four light distributions

Work



Compar linear

For office workstation lighting as of UGR<16

Slender profile

Four light distributions

Work

Pendant luminaires

Pendant downlights



www.erco.com/pendant



Atrium double focus

Indirect lighting available

Ideal for high and very high rooms

Very high visual comfort

Community, Contemplation



Jilly linear

For office workstation lighting as of UGR<16

Indirect lighting with tunable white available

Anti-glare louvre in various colours

Work



Compar linear

For office workstation lighting as of UGR<16

Indirect lighting with tunable white available

ERCO darklight technology

Work

Task lights

Task lights



www.erco.com/task-lights

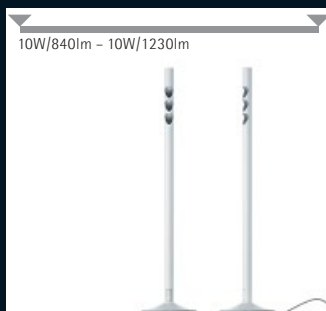

Lucy

Very high visual comfort

Touch dimmer with memory function

Rotatable through 180°

Work, Community

Wall luminaires

Ceiling washlights



www.erco.com/wall-luminaires

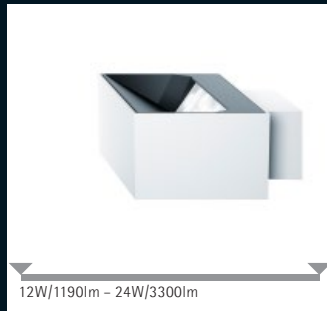

12W/1190lm - 24W/3300lm

Pantrac

Wide and narrow light distributions available

Excellent ceiling washlighting

Large luminaire spacing

Community, Culture

National Museum, Oslo

Architecture: Klaus Schuwerk, Arge Kleihues + Schuwerk.
Lighting design: Rambøll (architecture), Massimo Larussi, Florence (exhibition).
Photography: Tomasz Majewski
Exhibition design: Guicciardini & Magni Architetti, Florence.
Lighting coordinator: Magnus Mikaelson, Nationalmuseum Oslo
Graphic design (exhibition): Rovai Weber Design, Florence.



Stiehl Over Gehr-
mann, Osnabrück.
Architecture:
Plan Concept
Architekten,
Osnabrück.
Photography:
Lukas Palik



Projectors, floodlights and wallwashers



www.erco.com/projectors



Beamer

Very high visual comfort

Zoom projector and extensive accessories

RGBW and tunable white as well as Casambi Bluetooth available

Community, Culture



Kona

High visual comfort

Five sizes

Dimmable on the luminaire

Community, Public, Culture



Lightscan

Five sizes

Dimmable on the luminaire

Community, Public, Culture

Facade luminaires

Ceiling washlights and floor washlights



www.erco.com/facade



Lightscan

Ceiling washlighting

Wide and narrow light distributions available

Large luminaire spacing

Community



Kubus

Ground and facade lighting available

Wide and narrow light distributions available

Accessories for wall recessing available

Hospitality, Work



Focalflood

Impressive grazing light

Pivotable through 135°

Hospitality, Culture

Bollard luminaires

Floor washlights



www.erco.com/bollards

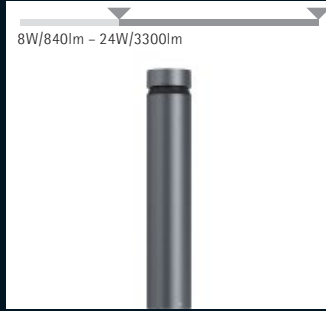

Castor

Available with 180° or 360° light distribution

100% Dark Sky compliant

Four sizes



Kubus

Wide and narrow light distributions available

100% Dark Sky compliant

Grazing light along the luminaire

Cittadella Bridge, Alexandria.
Architecture: Richard Meier & Partners Architects LLP. Interior design: Dante O. Benini & Partners. Lighting design: ENEL X. Photography: Edgar Zippel



Recessed luminaires

Downlights, wallwashers and directional spotlights



[www.erco.com/
downlights-r-ext](http://www.erco.com/downlights-r-ext)

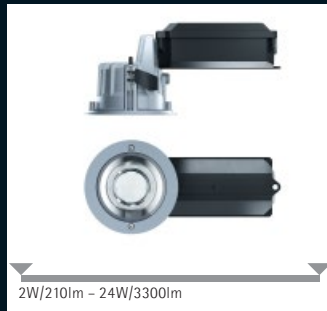

Quintessence round

Downlights, wallwashers and directional spotlight

Five light distributions

Very high visual comfort

Hospitality

Surface-mounted luminaires

Downlights



[www.erco.com/
downlights-s-ext](http://www.erco.com/downlights-s-ext)



Lightscan

Downlights in three sizes

Large lumen packages for high illuminances

Flat luminaire design

Hospitality, Community

In-ground luminaires

Wallwashers, uplights and directional spotlights



[www.erco.com/
ground-luminaires-ext](http://www.erco.com/ground-luminaires-ext)



Tesis

Pivotable directional spotlights for accent lighting

High uniformity with wallwashing

Six light distributions

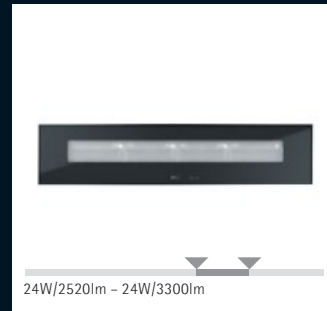

Site

Impressive grazing light

Very high visual comfort

Large luminaire spacing

Public, Hospitality

General Information

With the issue of this publication all previous documents become invalid. For the validity of this publication we reserve the right to make technical and formal changes to our products in the interests of improvement or to take account of changes in statutory regulations. We will gladly provide current data upon request.

All ERCO product documentation can be found at www.erco.com.

Many products are protected by industrial patent rights.

LED modules are part of the luminaire.

Voltages given in this catalogue refer to a mains frequency of 50/60Hz.

Installation in accordance with the respective national installation regulations.

The standard finish of our products is specified in the product description. The following colours can also be supplied: white RAL 9002, white RAL 9010, silver RAL 9006 and black RAL 9011. Other colours on request.

ERCO luminaires are designed, manufactured and tested in accordance with the applicable standards and technical regulations. The technical tests are implemented at 25°C ambient temperature.

The luminous flux values and photometric data also relate to a 25°C ambient temperature. Deviations to the specified data are possible with other temperatures.



Information about LEDs

Due to the production process of LEDs, the specified typical LED parameters show statistical values only. Deviations are possible within the typical size range of LEDs and are within the usual industrial tolerances. The service life of an LED largely depends on the ambient temperatures. Therefore, the luminaires should not be installed near other sources of heat such as heating pipes, etc. Furthermore, these luminaires should not be operated when exposed to direct sunlight. Current information about the LEDs can be found on the specification sheets of the respective articles.



DALI (Digital Addressable Lighting Interface)

DALI luminaires are activated by any DALI lighting control system. A control unit (e.g. dimmer) with DALI Broadcast Signal may be used for specific purposes. All electricians must be installed as specified in the DALI standard. ERCO DALI control gear is compatible with the DALI 2.0 standard. General information on DALI is available at www.digitalilluminationinterface.org.

RGBW luminaires

With use of a DALI system with colour management (device type 8) the luminaire is controlled with one address.

With operation in a system without colour management the luminaire can be reconfigured to three or four addresses.

Luminaires with tunable white

The tunable white component of a luminaire can only be controlled with a DALI system with colour management (device type 8). These systems detect the luminaire with one address. Alternatively, spotlights and recessed luminaires with tunable white can also be controlled via Casambi Bluetooth; individual product ranges can also be controlled via Zigbee 3.0.



Luminaires with Casambi Bluetooth

To control luminaires with Casambi Bluetooth, a mobile device with the free Casambi app or hardware approved for Casambi Bluetooth is required. The range of the Casambi mesh network can be affected by structural conditions.



Overvoltage protection for electronic control gear

If protection from spikes is required, e.g. when switching inductive loads, ERCO recommends the use of separate overvoltage protection units.

Electronic control gear in 3-circuit installation

To avoid damaging the electronic control gear, the neutral conductor of control gear in 3-circuit installations must never be disconnected.



Phase dimmable luminaires

LED luminaires can be dimmed depending on the type of control gear. Phase dimmable luminaires may only be used with suitable dimmers. Installation information in the mounting instructions of the luminaire and those of the dimmer manufacturer must be observed.

The dimming range specified in the product description is determined with regard to current dimmers. The actual dimming range available may vary from the product description, depending on the dimmer used and the load situation.

To ensure proper functioning of the dimmer, especially when using universal dimmers, check the luminaire/control gear/dimmer combination before installation.

Information on environmental protection and luminaire disposal

ERCO products are manufactured in compliance with the REACH regulation and the RoHS directive.

WEEE

The WEEE (Waste Electrical and Electronic Equipment) directive of the EU for electric and electronic devices regulates the free return and environmentally friendly disposal and recycling of old and used electrical equipment by manufacturers and importers. The Directive aims to reduce the amount of electrical and electronic waste and encourage everyone to recycle the equipment.



Disposing of luminaires

ERCO has met the requirements of the WEEE Directive since March 2006 in that it has clearly marked all its products with the symbol of the crossed-out bin. These products may be returned free of charge. Alternatively, at the end of their service life, luminaires may be disposed of at appropriate local facilities provided for the disposal or recycling of electronic equipment.



DIN EN ISO 9001:2015

The ERCO Quality Management System has been organised in accordance with DIN EN ISO 9001:2015. The certified system includes: design/development, production, assembly, sales and service. ERCO sales organisations worldwide are always included in the management system and are regularly audited by ERCO auditors.



DE AEOF 102810

ERCO GmbH was awarded the AEOF (Authorised Economic Operator Full) certificate on 27/8/2010. This certification confirms ERCO GmbH to be a particularly reliable and trustworthy partner in international trade. It governs the safety and efficiency of the supply chain through to the consumer.



The guarantee terms pertaining to the voluntary manufacturer's guarantee of 5 (five) years given by ERCO GmbH on ERCO products shall apply in addition to our General Terms and Conditions. Full details of these current guarantee terms are available on request by e-mailing guarantee@erco.com

Quickly find the right luminaire – the Product Finder at erco.com

- ✓ Simple search via features
- ✓ Numerous professional filters
- ✓ Clear results list
- ✓ Save and share results in myERCO
- ✓ Quick access at www.erco.com

Try the Product Finder now
www.erco.com

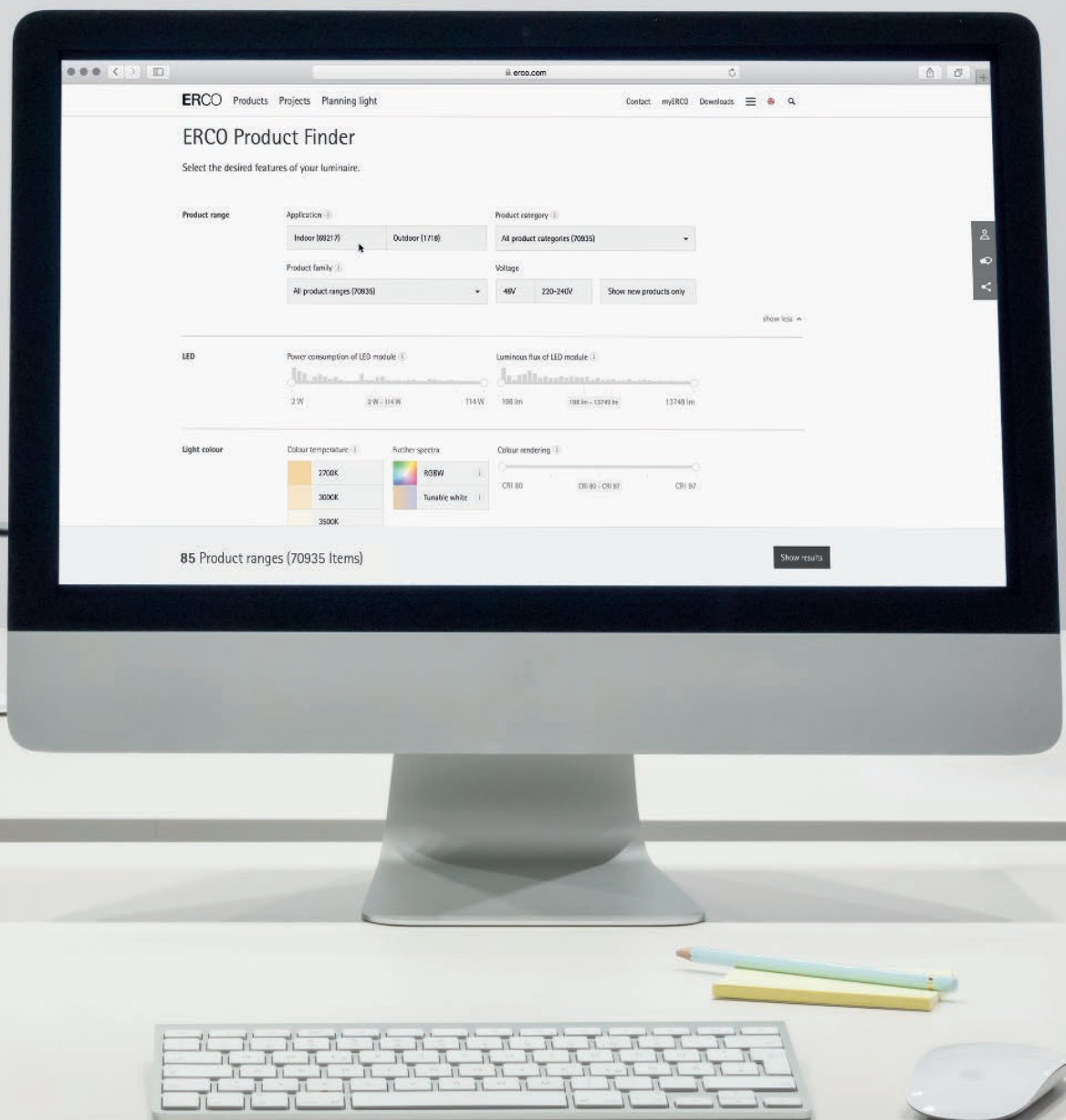

Light is the fourth dimension of architecture

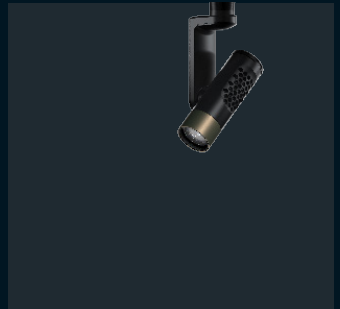
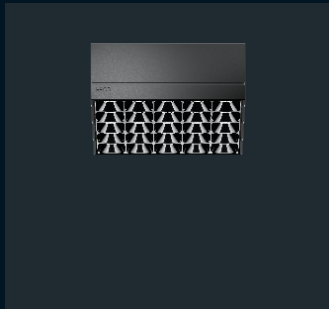
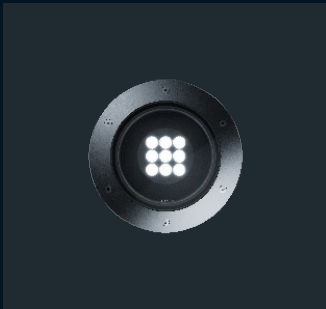
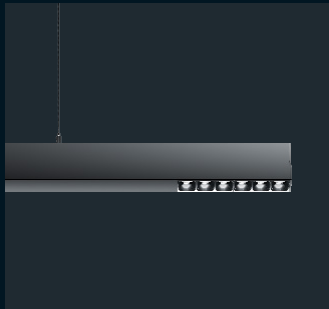

ERCO

Art. No. 152023012057
English 01/2023

